



Australian Government  
Great Barrier Reef  
Marine Park Authority



Reef  
Authority

# GREAT BARRIER REEF MARINE MONITORING PROGRAM

## Quality Control and Quality Assurance Manual 2022–23

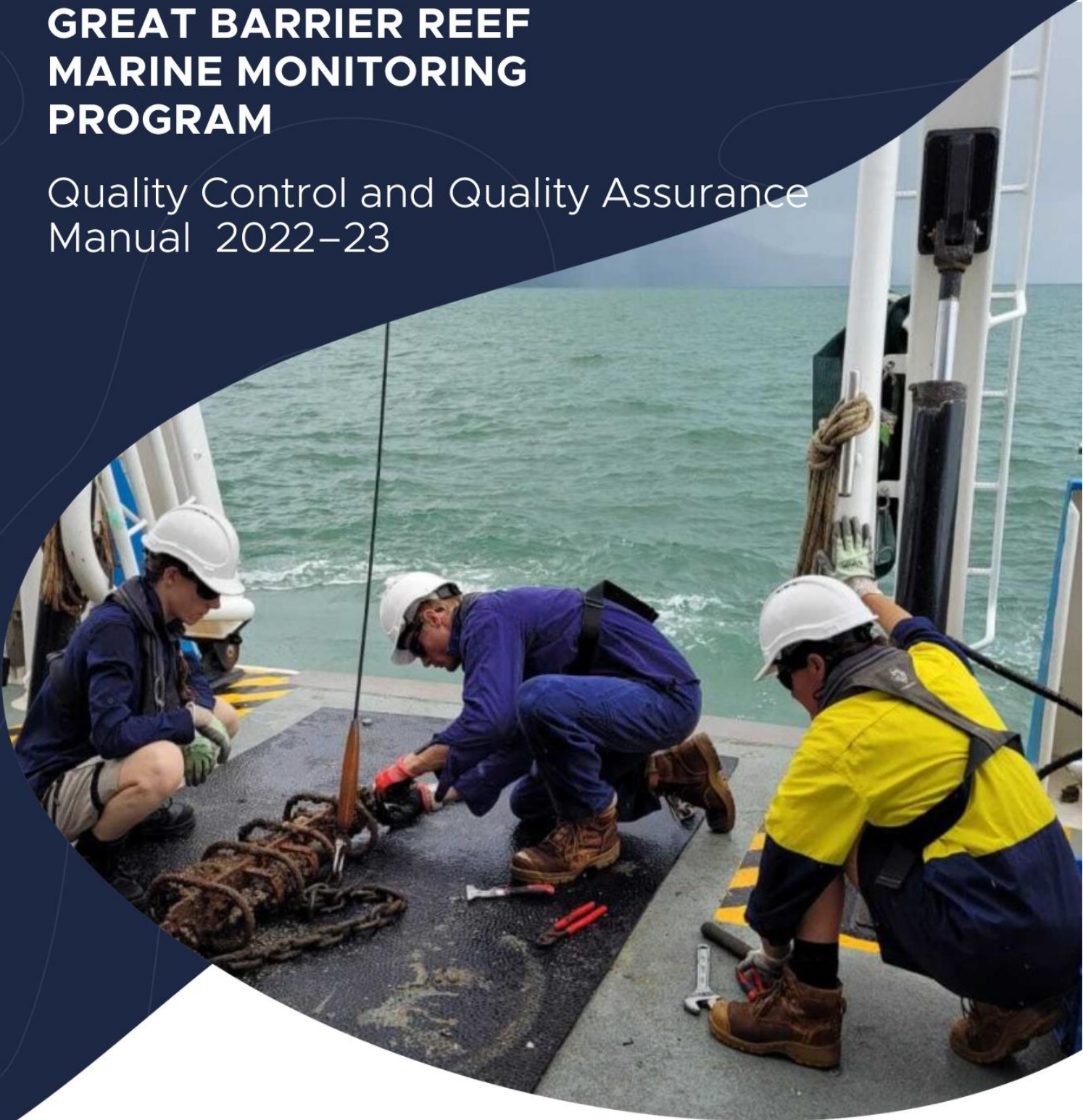

Australian Government



AUSTRALIAN INSTITUTE  
OF MARINE SCIENCE



THE UNIVERSITY  
OF QUEENSLAND  
AUSTRALIA



JAMES COOK  
UNIVERSITY  
AUSTRALIA



TropWATER



Water Partnership

© Commonwealth of Australia (Great Barrier Reef Marine Park Authority) 2024  
Published by the Great Barrier Reef Marine Park Authority

ISSN 2652 3329 (formerly ISSN 2200-4084)

This document is licensed by the Commonwealth of Australia for use under a Creative Commons By Attribution 4.0 International licence with the exception of the Coat of Arms of the Commonwealth of Australia, the logos of the Great Barrier Reef Marine Park Authority, Queensland Government, James Cook University, TropWater, University of Queensland, Cape York Water Quality Monitoring Partnership and any other material protected by a trademark, content supplied by third parties and any photographs. For licence conditions see: <http://creativecommons.org/licences/by/4.0>



**A catalogue record for this publication is available from the National Library of Australia**

**This publication should be cited as:**

Great Barrier Reef Marine Park Authority 2024, *Great Barrier Reef Marine Monitoring Program Quality Assurance and Quality Control Manual 2022-23*, Great Barrier Reef Marine Park Authority, Townsville, 189 pp.

The Great Barrier Reef Marine Park Authority gratefully acknowledges the contributions of the Marine Monitoring Program providers and their institutions to this manual.

Front cover image: Mooring Operations recovering instruments that have been deployed for four months.  
©Australian Institute of Marine Science. Photo credit: Irena Zagorskis.

The Great Barrier Reef Marine Park Authority acknowledges the continuing Sea Country management and custodianship of the Great Barrier Reef by Aboriginal and Torres Strait Island Traditional Owners whose rich cultures, heritage values, enduring connections and shared efforts protect the Reef for future generations.

## **DISCLAIMER**

While reasonable efforts have been made to ensure that the contents of this document are factually correct, AIMS does not make any representation or give any warranty regarding the accuracy, completeness, currency or suitability for any particular purpose of the information or statements contained in this document. To the extent permitted by law AIMS shall not be liable for any loss, damage, cost or expense that may be occasioned directly or indirectly through the use of or reliance on the contents of this document. Comments and questions regarding this document are welcome and should be addressed to:



**Australian Government**  
**Great Barrier Reef**  
**Marine Park Authority**

Great Barrier Reef Marine Park Authority  
PO Box 1379  
TOWNSVILLE QLD 4810  
Australia  
Phone: (07) 4750 0700  
Email: [info@gbbrmpa.gov.au](mailto:info@gbbrmpa.gov.au)  
[www.gbbrmpa.gov.au](http://www.gbbrmpa.gov.au)

## Table of Contents

<b>1</b>	<b>Introduction .....</b>	<b>1</b>
1.1	Inshore marine water quality monitoring.....	2
1.2	Remote sensing of water quality .....	3
1.3	Pesticide monitoring.....	4
1.4	Inshore coral monitoring.....	4
1.5	Inshore seagrass monitoring .....	5
1.6	Marine Monitoring Program quality assurance and quality control methods and procedures .....	5
<b>2</b>	<b>Inshore <i>in-situ</i> water quality monitoring.....</b>	<b>7</b>
2.1	Introduction .....	7
2.2	Methods .....	7
2.2.1	Sampling locations and frequency.....	7
2.2.2	Sample collection, preparation, and analysis (AIMS) .....	12
2.2.3	Autonomous environmental water quality loggers (AIMS).....	14
2.2.4	Sample collection, preparation, and analysis (JCU and CYWP) .....	16
2.2.5	Sample collection, preparation, and analysis: wet season flood events (JCU and CYWP) .	19
2.3	Data management.....	20
<b>3</b>	<b>Remote sensing and modelling of the Reef water quality and river flood plumes ..</b>	<b>21</b>
3.1	Introduction .....	21
3.2	Methods .....	25
3.2.1	Optical satellite data .....	26
3.2.2	Colour classifications.....	28
3.2.3	Production of weekly wet season water type maps.....	29
3.2.4	Production of annual, multi-annual and typical Wet and Dry wet season water type maps .	30
3.2.5	Surface loading maps.....	31
3.2.6	Mean long-term water quality concentrations across water types and colour classes.....	32
3.2.7	Exposure maps and exposure assessment.....	34
<b>4</b>	<b>Pesticide monitoring .....</b>	<b>40</b>
4.1	Introduction .....	40
4.2	Methods .....	41
4.2.1	Sampling design — Passive sampling for routine monitoring.....	41
4.2.2	Target pesticides in the different passive samplers.....	41
4.2.3	Chemical analysis .....	44
4.2.4	Passive sampling techniques .....	44
4.2.5	Risk assessment metrics:.....	48
4.2.6	QA/QC procedures in the pesticide monitoring program .....	49
4.3	Data management and security .....	50
4.4	Summary.....	50
<b>5</b>	<b>Inshore coral reef monitoring.....</b>	<b>51</b>
5.1	Introduction .....	51
5.2	Methods .....	52
5.2.1	Sampling design.....	52
5.2.2	Site selection .....	52
5.2.3	Depth selection.....	56
5.2.4	Field survey methods .....	57
5.2.5	Observer training.....	59
5.2.6	Temperature monitoring .....	60
5.3	Data management.....	60
5.4	Summary of Quality Control measures .....	61
<b>6</b>	<b>Inshore seagrass monitoring .....</b>	<b>62</b>

6.1	Introduction .....	62
6.2	Methods .....	62
6.2.1	Sampling design.....	62
6.2.0	Field survey methods .....	63
6.2.1	Observer training.....	69
6.2.2	Laboratory analysis .....	70
6.2.3	Temperature monitoring within seagrass canopy .....	71
6.2.4	Light monitoring at seagrass meadow canopy .....	72
6.2.5	Light logger calibration procedure .....	74
6.3	Data management.....	75
6.3.1	Meadow abundance, community structure, reproductive health and extent.....	75
6.3.2	Temperature monitoring within seagrass canopy .....	75
6.3.3	Light monitoring at seagrass meadow canopy .....	76
6.4	Summary of Quality Control measures .....	76
6.4.1	Meadow abundance, community structure, reproductive health and extent.....	76
6.4.2	Temperature monitoring within seagrass canopy .....	76
6.4.3	Light monitoring at seagrass meadow canopy .....	76
<b>7</b>	<b>References.....</b>	<b>78</b>
	<b>Appendix A Detailed Manuals and Standard Operating Procedures.....</b>	<b>84</b>
	Appendix A1: Operating instructions for the AIMS Sea-Bird CTD.....	86
	Appendix A2: Measuring salinity using the Portasal Salinometer 8410A .....	90
	Appendix A3: Automated analysis of dissolved nutrients in seawater .....	106
	Appendix A4: Dissolved Organic Carbon and Total Nitrogen Assay in Water using the Shimadzu TOC-L ....	113
	Appendix A5: Measuring CDOM in water samples using the Shimadzu 1900UV-Vis spectrophotometer .....	119
	Appendix A6: Analysis of particulate phosphorus in marine waters .....	126
	Appendix A7: Carbon and Nitrogen Assay in Solids using the Shimadzu TOC-L with SSM.....	136
	Appendix A8: Analysis of Chlorophyll-a in marine waters .....	142
	Appendix A9: Measuring total suspended solids in seawater .....	150
	Appendix A10: AIMS In-house procedures for WET Labs FLNTUSB ECO logger .....	156
	Appendix A11: AIMS Data Management Procedures for the Marine Monitoring Program .....	175
	<b>Appendix B Waypoints for Coral Monitoring Transects .....</b>	<b>181</b>
	Appendix B1 Waypoints for the start of Transect 1 of each coral site reported by the MMP. Reefs in Italics are monitored by the AIMS Long-term Monitoring Program.....	181

## List of figures

Figure 2-1 Site locations of the water quality monitoring sampled from 2015 onwards .....	11
Figure 2-2 Correlation between instrument readings of turbidity (NTU) from field deployments of WET Labs Eco FLNTUSB loggers with values from concurrently collected total suspended solids (TSS) samples.....	16
Figure 3-1 Triangular colour plot showing the characteristic colour signatures of the wet season water types in the Red-Green-Blue (RGB or true colour) space.....	22
Figure 3-2 Summary description of the wet season water quality products. ....	26
Figure 3-3 Long-term (2004–2023) concentrations of water quality parameters and Secchi depth boxplots for each Reef water type .....	34
Figure 3-4 (top) Mean long-term water quality concentrations and (bottom) magnitude score across the three wet season water types.....	35
Figure 3-5 Boundaries used for the Marine Park, each NRM region, and the coral reefs and seagrass ecosystems.....	39
Figure 4-1 An Empore Disk being loaded into the Teflon Chemcatcher housing (left) and an assembled housing ready for deployment (right) .....	46
Figure 4-2 Passive flow monitors pre-deployment (left) and post-deployment (right) .....	46
Figure 4-3 Relationship between flow and sampling rates of specific herbicides indicating a shift from aqueous boundary layer control to diffusion limiting membrane control under higher flow conditions.....	47
Figure 5-1 Sampling design for coral reef benthic community monitoring. Terms within brackets are nested within the term appearing above. ....	52
Figure 5-2 Coral locations that exist as of 2021. ....	54
Figure 6-1 Inshore seagrass locations that exist as of 2022–23. However, not all locations were assessed or sampled in 2022–23.....	64
Figure 6-2 Form and size of reproductive structure of the seagrasses collected: <i>Halophila ovalis</i> , <i>Halodule uninervis</i> and <i>Nanozostera muelleri</i> .....	70

## List of tables

Table 1-1 Current monitoring themes, sub-programs and monitoring providers.....	1
Table 2-1 Description of the water quality sites sampled by AIMS, JCU, and CYWP during 2022–23..	8
Table 2-2 Summary of sampling protocols with identification of post-sampling procedures, laboratory containers, and storage techniques.....	18
Table 3-1 Description of the Sentinel-3 Reef water types (WT) and corresponding Forel-Ule (FU) colour classes .....	24
Table 3-2 Keywords and justification used in SeaDAS 7.4 to process MODIS true colour images of the Great Barrier Reef. ....	27
Table 3-3 Wettest and driest years used to compute the typical wet and typical dry composite frequency maps in each NRM region .....	30
Table 3-4 Reef-wide wet season guideline values used to calculate the exposure score for satellite exposure maps .....	36
Table 3-5 Number of collected <i>in situ</i> samples used in exposure scoring by region and water type ...	37
Table 4-1 List of Targeted Pesticides with corresponding LOQ for both ED and grab water samples.	42
Table 5-1 Scheduled coral monitoring sampling design for the MMP .....	54
Table 5-2 Distribution of sampling effort .....	56
Table 5-3 Observer training methods and quality measures .....	59
Table 6-1 Inshore seagrass long-term monitoring sites surveyed in 2022–23.....	65

Table 6-2 Extra inshore seagrass long-term monitoring sites from the Seagrass-Watch and QPWS drop-camera programs surveyed in 2022–23. NRM region from <a href="http://www.nrm.gov.au">www.nrm.gov.au</a> . * = intertidal, ^ = subtidal. ....	67
Table 6-3 Monitoring sites selected for light logger data collection. ....	72

**List of acronyms**

<b>AIMS</b> .....	Australian Institute of Marine Science
<b>Authority</b> .....	Great Barrier Reef Marine Park Authority
<b>ANZECC</b> .....	Australian and New Zealand Environment and Conservation Council
<b>ARMCANZ</b> .....	Agriculture and Resource Management Council of Australia and New Zealand
<b>CYWP</b> .....	Cape York Water Partnership
<b>CDOM</b> .....	Coloured dissolved organic matter
<b>Chl-a</b> .....	Chlorophyll a
<b>CTD</b> .....	Conductivity Temperature Depth profiler
<b>DIN</b> .....	Dissolved inorganic nitrogen
<b>DOC</b> .....	Dissolved organic carbon
<b>HPLC</b> .....	High-performance liquid chromatography
<b>JCU</b> .....	James Cook University
<b>LC-MS</b> .....	Liquid chromatography-mass spectrometry
<b>MMP</b> .....	Great Barrier Reef Marine Monitoring Program
<b>MODIS</b> .....	Moderate-resolution imaging spectroradiometer
<b>MS</b> .....	Mass spectrometry
<b>NASA</b> .....	National Aeronautics and Space Administration
<b>NATA</b> .....	National Association of Testing Authorities
<b>NH<sub>3</sub></b> .....	Ammonia
<b>NO<sub>2</sub></b> .....	Nitrite
<b>NO<sub>3</sub></b> .....	Nitrate
<b>NO<sub>x</sub></b> .....	Nitrate/nitrite (NO <sub>3</sub> + NO <sub>2</sub> )
<b>NRM</b> .....	Natural resource management
<b>PN</b> .....	Particulate nitrogen
<b>PO<sub>4</sub></b> .....	Dissolved inorganic phosphorus(phosphate)
<b>POC</b> .....	Particulate organic carbon
<b>PP</b> .....	Particulate phosphorus
<b>QA/QC</b> .....	Quality assurance/quality control
<b>QHFSS</b> .....	Queensland Health Forensic & Scientific Service
<b>Si(OH)<sub>4</sub></b> .....	Silicate
<b>SOPs</b> .....	Standard operating procedures
<b>TDN</b> .....	Total dissolved nitrogen
<b>TDP</b> .....	Total dissolved phosphorus
<b>TN</b> .....	Total nitrogen
<b>TP</b> .....	Total phosphorus
<b>TropWATER</b> .....	Centre for Tropical Water and Aquatic Ecosystem Research
<b>TSS</b> .....	Total suspended solids

## 1 Introduction

This manual describes the quality assurance and quality control (QA/QC) processes undertaken as part of the Great Barrier Reef Marine Monitoring Program (MMP) activities associated with the annual technical reports for the 2022–23 monitoring year. The MMP is a collaborative effort that relies on effective partnerships between governments, industry, community, scientists, and managers. The Great Barrier Reef Marine Park Authority (the Authority) is responsible for the management of the MMP in partnership with monitoring partners including:

- Australian Institute of Marine Science (AIMS)
- James Cook University (JCU)
- University of Queensland (UQ)
- Howley Environmental Consulting/Cape York Water Partnership (CYWP)

We work together to deliver the sub-programs of the MMP which monitor the inshore marine environment including water quality, seagrass, coral and pesticides. The broad objectives of this monitoring include:

- **Inshore marine water quality monitoring:** To assess temporal and spatial trends in marine water quality in inshore areas of the Reef lagoon in both ambient and wet season flood events.
- **Inshore seagrass monitoring:** To quantify temporal and spatial variation in the status of intertidal and subtidal seagrass meadows in relation to local water quality changes.
- **Inshore coral reef monitoring:** To quantify temporal and spatial variation in the status of inshore coral reef communities in relation to local water quality changes.

**Inshore pesticide monitoring:** To assess the presence of pesticides in inshore areas of the Reef lagoon and identify any temporal and spatial trends. Each monitoring provider has a different responsibility in the delivery of the sub-programs that make up the monitoring sub-programs of the MMP (Table 1-1) including a description of the process for calculating Reef Water Quality Report Card scores (reported under the Reef 2050 Water Quality Improvement Plan, WQIP).

Table 1-1 Current monitoring themes, sub-programs and monitoring providers.

Monitoring sub-program	Component project(s)	Monitoring provider
Inshore marine water quality	Routine water quality monitoring (ambient conditions)	AIMS, JCU, and CYWP
	Event-based water quality monitoring (flood events)	JCU and CYWP
	Mapping (satellite imagery) and modelling (eReefs model outputs) of water quality	JCU
Inshore seagrass condition	Inshore seagrass monitoring	JCU
Inshore coral reef condition	Inshore coral monitoring	AIMS

Inshore pesticide presence	Pesticide monitoring	UQ (deployment by several providers including JCU and AIMS)
----------------------------	----------------------	---

## 1.1 Inshore marine water quality monitoring

Long-term *in situ* monitoring of spatial and temporal trends in the inshore water quality of the Reef lagoon is essential to assess improvements in regional water quality that are expected to occur as a result of reductions in nutrient and sediment loads from adjacent catchments. In addition, understanding what is delivered by flood waters is essential to quantify the exposure of inshore ecosystems to these loads.

The MMP water quality design was reviewed in 2014. A conceptual model (Haynes *et al.* 2007) and the Driver, Pressure, State, Impact, and Response (DPSIR) framework were used to identify indicators linking water quality and ecosystem health, which were refined in consultation with monitoring providers and independent experts. Program design recommendations were based on a statistical review (Kuhnert *et al.* 2015). The new sampling design for the inshore water quality monitoring program was implemented in 2015, to increase the detection of links between end-of-catchment loads and marine water quality through higher frequency sampling at a larger number of sites in the focus area. The design focused on four regions: the Russell-Mulgrave, Tully, Burdekin, and Mackay-Whitsunday. Extra reporting for the Barron-Daintree sub-region of the Wet Tropics was also included due to the continued collection of data along AIMS' long-term 'Cairns transect' where sampling started in 1989. In 2016–17, four focus regions were added in Cape York relevant to the Pascoe, Normanby-Kennedy, Annan-Endeavour and Stewart Rivers.

In 2020–21, monitoring was reinstated in the Fitzroy NRM region with funding from the Reef Trust Partnership (RTP) between the Australian Government and the Great Barrier Reef Foundation and co-investment by AIMS. Water quality monitoring in this region is not a part of the MMP but it is conducted at the same sites and using the same sampling design principles that are implemented across the MMP.

The sites in each focus area are located to capture water masses along cross-shelf and alongshore gradients. The site selection in the focus areas was informed by the plume frequency model (Petus *et al.* 2014a; Devlin *et al.* 2013) and the river tracer model (Brinkman *et al.* 2014).

Monitoring includes measurement of dissolved and particulate nutrients (nitrogen and phosphorus) and carbon, total suspended solids (TSS), chlorophyll *a* (Chl-*a*), silica [Si(OH)<sub>4</sub>], salinity, turbidity, coloured dissolved organic matter (CDOM) and temperature. Additionally, samples for pesticides are collected in the wet season at high-risk sites.

Techniques used are a combination of:

- continuous measurement of salinity and temperature at seven stations (two additional stations in the Fitzroy),
- continuous measurement of Chl-*a* and turbidity at 16 stations (three additional stations in the Fitzroy),
- 49 ambient stations sampled during the year with more frequent sampling during the wet season (6 additional stations in the Fitzroy), and

- 33 additional event-based stations sampled during flood conditions.

Wet season water quality conditions and the movement of flood plumes is assessed using images from remote sensing (Sentinel-3) imagery (see Chapter 3) supported by in-situ data.

The revised design supports closer integration between MMP components, leading to outputs that are expected to meet stakeholder needs, including:

- a robust data foundation and continuous improvement of all reporting metrics (those in the Reef Water Quality Report Card reports, as per WQIP);
- improved reporting of pressure indicators via models of exposure that link marine water quality to end-of-catchment loads (*water quality as a state*);
- a robust data foundation for detecting, attributing and interpreting relationships between water quality and coral reef and seagrass condition (*water quality as a pressure*); and
- ongoing validation of the eReefs model and satellite imagery to allow for more confident predictions of water quality in areas that are not monitored.

## 1.2 Remote sensing of water quality

The use of remotely sensed data in combination with *in situ* water quality measurements provides a powerful source of data in the assessment of water quality across the Reef. Remote sensing studies using derived water quality level-2 products and ocean colour satellite images reclassified to optical water type maps have been used to map and characterise the spatial and temporal distribution of river plumes, and understand the impact of these river plumes on Reef ecosystems.

To define and map wet season conditions, and the movement, composition and frequency of occurrence of wet season water quality conditions across the Reef, current remote sensing methods use the colour of the ocean retrieved by optical satellite imageries to classify Reef waters into Optical Water Types. Catchment run-off in sediment-laden river discharge appears in satellite images as brownish floodwaters, while productive waters appear with a greenish colour and ambient (clear) marine waters with a bluish colour. The water type maps are used to describe typical colour and water quality gradients encountered in the Reef during the wet season, including river plumes. Methods have been historically based on the extraction and analysis of Moderate-Resolution Imaging Spectroradiometer (MODIS) true colour data. However, MODIS sensors are ageing (MODIS-Aqua was launched in 2002) and the quality of the MODIS imagery is declining. The use of Sentinel-3 Ocean Land Colour Instrument (OLCI) satellite imagery was proposed for the continuous mapping of Reef waters in Petus *et al.* (2019) and was implemented in the MMP in 2020.

To understand wet season marine water quality conditions and identify where seagrass and coral reefs may be at risk from water quality influences, several products derived from Sentinel-3 satellite imagery are produced. These include weekly panels of maps showing regional environmental and marine wet season conditions, Reef-wide maps representing the frequency of occurrence of wet season water types and maps that estimate exposure to wet season water quality conditions. Exposure is assessed in terms of the area (km<sup>2</sup>) and

percentage (%) of coral reefs and seagrass meadows affected by different categories of exposure (or potential risk).

### 1.3 Pesticide monitoring

The off-site transport of pesticides from land-based applications has been considered a potential risk to the Reef. Of particular concern is the potential for compounding effects that these chemicals have on the health of the inshore reef ecosystem, especially when delivered with other water quality pollutants during flood events (this project is also linked to flood plume monitoring and the collection of water samples directly from research vessels, Section 2).

Passive samplers are used to measure the concentration of pesticides in the water column integrated over time by accumulating chemicals via passive diffusion. The monitoring of specific pesticides during flood events and throughout the wet season is essential to evaluate long-term trends in pesticide concentrations along inshore waters of the Reef. Key points include:

- pesticide concentrations are measured with passive samplers at selected sites (sampling occurred at 10 fixed sites in 2022–23) at monthly intervals during the wet season.
- pesticide concentrations are assessed against relevant Guidelines (Australian and New Zealand Governments 2018; Great Barrier Reef Marine Park Authority 2010). Note that new pesticide guideline values are also reported as categories of sub-lethal stress defined by the published literature and taking into account mixtures of herbicides that affect photosynthesis.
- the continual refinement of techniques that allow a more sensitive, time-integrated and relevant approach for monitoring pollutant concentrations in the lagoon and assessment of potential effects that these pollutants may have on key biota.

### 1.4 Inshore coral monitoring

Coral reefs in inshore areas of the Reef are frequently exposed to runoff (Furnas and Brodie 1996). Monitoring temporal and spatial variation on the status of inshore coral reef communities in relation to changes in local water quality is essential in evaluating long-term ecosystem health.

Monitoring covers a comprehensive set of community attributes including the assessment of hard and soft coral cover, macroalgal cover, density of juvenile hard coral colonies, hard coral community composition and the rate of change in coral cover as an indication of the recovery potential of the reef following a disturbance (Thompson *et al.* 2020). In addition, the incidence of ongoing coral mortality is recorded and, where possible, attributed to the causative agent. Comprehensive water quality measurements are also collected at many of the coral reef sites (this project is linked to inshore water quality monitoring, Chapter 2). Key points include:

- reefs are monitored annually at 30 inshore coral reefs in the Wet Tropics, Burdekin, Mackay Whitsunday and Fitzroy regions along gradients of exposure to run-off from regionally important rivers.
- for reefs not scheduled for monitoring in a given year contingency sampling is undertaken when a disturbance was likely to have impacted reef since it was last monitored.
- at each reef, two sites are monitored at two depths (two metres and five metres) across five replicate transects.
- in addition to the monitoring of benthic community attributes, the measurement of sea temperature as an indicator of thermal stress is included.

### 1.5 Inshore seagrass monitoring

Seagrasses are an important component of the marine ecosystem of the Reef. They form highly productive habitats that provide nursery grounds for many marine and estuarine species. Monitoring temporal and spatial variation in the status of inshore seagrass meadows in relation to changes in local water quality is essential in evaluating long-term ecosystem health. The seagrass monitoring project is closely linked to the global Seagrass-Watch monitoring program (<http://www.seagrasswatch.org>).

Monitoring includes seagrass abundance (% cover) and species composition, macroalgal cover, epiphyte cover, canopy height, mapping of the meadow landscape (extent) and assessment of seagrass reproductive effort, which provide an indication of the capacity for meadows to regenerate following disturbances and changed environmental conditions. Key points include:

- monitoring occurs at 47 sites across 22 locations, including 13 nearshore (estuarine, coastal and fringing reef) and nine offshore reef locations.
- monitoring is conducted during the late-dry season and post-wet season; extra sampling is conducted at more accessible locations in the dry and monsoon seasons.
- monitoring includes *in situ* within canopy temperature and light levels.
- data is also collected annually from an additional 33 sites across 19 locations by Seagrass-Watch (intertidal) and Queensland Parks and Wildlife Service (QPWS; subtidal drop-camera) during the late-dry season (Please note: 5 of the additional sites occur within 3 locations monitored by MMP).

### 1.6 Marine Monitoring Program quality assurance and quality control methods and procedures

Appropriate QA/QC procedures are an integral component of all aspects of sample collection and analysis. These QA/QC procedures have been approved by an expert panel convened by the Authority. The Authority set the following guidelines for implementation by MMP program leaders:

- Appropriate methods must be in place to make sure of consistency of in-field procedures to produce robust, repeatable and comparable results, including consideration of sampling locations, replication and frequency.

- All methods used must be fit-for-purpose and suited to a range of conditions.
- Appropriate accreditation of participating laboratories or provision of standard laboratory protocols to demonstrate that appropriate laboratory QA/QC procedures are in place for sample handling and analysis.
- Participation in inter-laboratory performance testing trials and regular exchange of replicate samples between laboratories.
- Rigorous procedures to guarantee 'chain of custody' and tracking of samples.
- Appropriate standards and procedures for data management and storage.

In addition to the QA/QC procedures outlined above, the MMP employs a proactive approach to monitoring through the continual development of new methods and the refinement of existing methods, such as the:

- operation and validation of autonomous environmental loggers,
- validation of algorithms used for the remote sensing of water quality,
- improvement of passive sampling techniques for pesticides, and
- introduction of extra monitoring sub-programs to evaluate the condition of inshore reefs, specifically coral recruitment.

The monitoring providers for the MMP have a long-standing culture of QA/QC in their monitoring activities. Common elements across the providers include:

- ongoing training of staff (and other sampling providers) in relevant procedures,
- standard operating procedures (SOPs), both for field sampling and analytical procedures,
- use of standard methods (or development of modifications),
- publishing of methods and results in peer-reviewed publications,
- maintenance of equipment,
- calibration procedures including participation in regular inter-laboratory comparisons,
- established sample custody procedures,
- QC checks for individual sampling regimes and analytical protocols, and
- procedures for data entry, storage, validation and reporting.

This manual summarises the monitoring methods and procedures for each project. Detailed sampling manuals, SOPs, analytical procedures and other details are provided as appendices.

## 2 Inshore *in-situ* water quality monitoring

Renee Gruber<sup>2</sup>, Jane Waterhouse<sup>1</sup>, Daniel Moran<sup>2</sup>, Stephen Lewis<sup>1</sup>, Caroline Petus<sup>1</sup>, Christina Howley<sup>3</sup>, Ulysse Bove<sup>2</sup>, Jack Massuger<sup>2</sup>, Jane Mellors<sup>1</sup>, Mark O’Callaghan<sup>1</sup>, and Murray Logan<sup>2</sup>

<sup>1</sup>James Cook University, <sup>2</sup>Australian Institute of Marine Science, <sup>3</sup>Howley Environmental Consulting

### 2.1 Introduction

The aim of water quality monitoring is to assess the concentrations and transport of terrestrially-derived components, with a focus on the movement of TSS, Chl-*a*, and particulate and dissolved nutrients into the Reef lagoon. The MMP inshore water quality monitoring program informs the Paddock to Reef Integrated Monitoring, Modelling and Reporting Program (Paddock to Reef Program) by:

- Describing spatial patterns and temporal trends in inshore concentrations of sediment, Chl-*a*, and nutrients as assessed against the Guidelines (or other water quality guidelines if appropriate);
- Monitoring local water quality using autonomous instruments for high-frequency measurements at selected inshore locations;
- Determining three-dimensional extent and duration of flood plumes and linking concentrations of suspended sediment, nutrients, and pesticides to end-of-catchment loads;
- Calculating the Water Quality Index and site-specific metrics for nutrients, turbidity, and suspended solids; and
- Establishing the extent, frequency, and intensity of impacts on Reef inshore seagrass meadows and coral reefs from flood plumes and the link to end-of-catchment loads.

### 2.2 Methods

#### 2.2.1 Sampling locations and frequency

The current design of the joint AIMS, TropWATER, and CYWP sampling program comprises routine sampling sites visited throughout the year, with sampling at additional sites during flood events (Table 2-1, Figure 2-1). The sampling sites are located across focus areas in five NRM regions: Cape York (Pascoe, Stewart, Normanby-Kennedy, and Annan-Endeavour); Wet Tropics (Barron-Daintree, Russell-Mulgrave and Tully); Burdekin; Mackay Whitsunday; and Fitzroy. At these sites, detailed manual and instrumental water sampling is undertaken.

Table 2-1 Description of the water quality sites sampled by AIMS, JCU, and CYWP during 2022–23. The proposed number of visits is shown. Sampling in the Fitzroy region from 2020 is conducted through a partnership between AIMS and the RTP.

Site Location		Logger Deployment		Ambient sampling at fixed sites		Event-based sampling
NRM Region and Focus Area	Short Name	Turbidity and chlorophyll	Salinity	Number of times (season) site is visited/year by AIMS	Number of times (season) site is visited/year by JCU/CYWP	Additional sampling/year by JCU/CYWP
<b>Cape York</b>						
<b>Normanby-Kennedy Focus Area</b>						
	Kennedy River mouth					✓
	Kennedy inshore					✓
	Bizant River mouth					✓
	Normanby River mouth					✓
	Normanby inshore				4 (4 wet)	
	NR-03				4 (4 wet)	
	NR-04				4 (4 wet)	
	NR-05				4 (4 wet)	
	Corbett Reef				4 (4 wet)	
<b>Pascoe Focus Area</b>						
	Pascoe River mouth south				5 (5 wet or 4 wet and 1 dry) (Surface sample only)	
	PR-North 02				5 (5 wet or 4 wet and 1 dry) (Surface sample only)	
	Eel Reef-North					✓
	PR-South 2.5				5 (5 wet or 4 wet and 1 dry)	
	Middle Reef				5 (5 wet or 4 wet and 1 dry)	
	Eel Reef South				5 (5 wet or 4 wet and 1 dry)	
<b>Annan-Endeavour Focus Area</b>						
	Annan mouth					✓
	Walker Bay				5 (5 wet or 4 wet and 1 dry)	
	Dawson Reef				5 (5 wet or 4 wet and 1 dry)	
	Dawson FLNTU				4 (4 wet) (Surface sampling only)	
	Endeavour mouth					✓
	Endeavour north shore				5 (5 wet or 4 wet and 1 dry)	
	Endeavour offshore				5 (5 wet or 4 wet and 1 dry)	
	Egret and Boulder Reef				5 (5 wet or 4 wet and 1 dry)	

Forrester Reef FLNTU	FR-FLNTU	✓			4 (4 wet) (Surface sampling only)	
<b>Stewart Focus Area</b>						
Stewart River	SR02				5 (5 wet or 4 wet and 1 dry)	
S3	SR03				5 (5 wet or 4 wet and 1 dry)	
Burkitt Island	SR04				5 (5 wet or 4 wet and 1 dry)	
Hannah Island	SR05				5 (5 wet or 4 wet and 1 dry)	
Cliff Islands	CI01				4 (4 wet)	
<b>Wet Tropics</b>						
<b>Barron-Daintree Focus Area</b>						
Cape Tribulation*	C1			3 (1 wet and 2 dry)		
Port Douglas*	C4			3 (1 wet and 2 dry)		
Double Island*	C5			3 (1 wet and 2 dry)		
Yorkey's Knob*	C6			3 (1 wet and 2 dry)		
Fairlead Buoy*	C8			3 (1 wet and 2 dry)		
Green Island*	C11			3 (1 wet and 2 dry)		
<b>Russell-Mulgrave Focus Area</b>						
Fitzroy Island West*	RM1	✓		5 (3 wet and 2 dry)		
RM2	RM2					✓
RM3	RM3			5 (3 wet and 2 dry)	5 (4 wet and 1 dry)	
RM4	RM4					✓
High Island East	RM5					✓
Normanby Island	RM6					✓
Frankland Group West (Russell Isl.)*	RM7	✓		5 (3 wet and 2 dry)	5 (4 wet and 1 dry)	
High Island West*	RM8	✓	✓	5 (3 wet and 2 dry)	5 (4 wet and 1 dry)	
Palmer Point	RM9					✓
Russell-Mulgrave River mouth mooring	RM10	✓	✓	5 (3 wet and 2 dry)	5 (4 wet and 1 dry)	
Russell-Mulgrave River mouth	RM11					✓
Russell-Mulgrave junction [River]	RM12					✓
<b>Tully Focus Area</b>						
King Reef	TUL1					✓
East Clump Point	TUL2			5 (3 wet and 2 dry)	5 (4 wet and 1 dry)	
Dunk Island North*	TUL3	✓	✓	5 (3 wet and 2 dry)	5 (4 wet and 1 dry)	
South Mission Beach	TUL4					✓
Dunk Island South East	TUL5			5 (3 wet and 2 dry)	5 (4 wet and 1 dry)	
Between Tam O'Shanter and Timana	TUL6			5 (3 wet and 2 dry)	5 (4 wet and 1 dry)	
Hull River mouth	TUL7					✓
Bedarra Island	TUL8			5 (3 wet and 2 dry)	5 (4 wet and 1 dry)	
Triplets	TUL9					✓
Tully River mouth mooring	TUL10	✓	✓	5 (3 wet and 2 dry)	5 (4 wet and 1 dry)	
Tully River	TUL11					✓

<b>Burdekin</b>						
<b>Burdekin Focus Area</b>						
Pelorus and Orpheus Island West*	BUR1	✓		4 (2 wet and 2 dry)	5 (5 wet and 0 dry)	
Pandora Reef*	BUR2	✓		4 (2 wet and 2 dry)	5 (5 wet and 0 dry)	
Cordelia Rocks	BUR3					✓
Magnetic Island (Geoffrey Bay)*	BUR4	✓		4 (2 wet and 2 dry)	5 (5 wet and 0 dry)	
Inner Cleveland Bay	BUR5					✓
Cape Cleveland	BUR6					✓
Haughton 2	BUR7			4 (2 wet and 2 dry)	5 (5 wet and 0 dry)	
Haughton River mouth	BUR8					✓
Barratta Creek	BUR9					✓
Yongala IMOS NRS	BUR10			4 (2 wet and 2 dry)		
Cape Bowling Green	BUR11					✓
Plantation Creek	BUR12					✓
Burdekin River mouth mooring	BUR13	✓	✓	4 (2 wet and 2 dry)	5 (5 wet and 0 dry)	
Burdekin Mouth 2	BUR14					✓
Burdekin Mouth 3	BUR15					✓
<b>Mackay-Whitsunday</b>						
<b>O'Connell Focus Area</b>						
Double Cone Island*	WHI1	✓		5 (3 wet and 2 dry)		
Hook Island W	WHI2					✓
North Molle Island	WHI3					✓
Pine Island*	WHI4	✓	✓	5 (3 wet and 2 dry)		
Seaforth Island	WHI5	✓		5 (3 wet and 2 dry)		
O'Connell River mouth	WHI6	✓	✓	5 (3 wet and 2 dry)		
Repulse Islands dive mooring	WHI7			5 (3 wet and 2 dry)		
Rabbit Island NE	WHI8					✓
Brampton Island	WHI9					✓
Sand Bay	WHI10					✓
Pioneer River mouth	WHI11					✓
<b>Fitzroy</b>						
<b>Fitzroy Focus Area</b>						
Barren Island*	FTZ1	✓		10 (7 wet and 3 dry)		
Humpy Island*	FTZ2	✓	✓	10 (7 wet and 3 dry)		
Pelican Island*	FTZ3			10 (7 wet and 3 dry)		
North Keppel	FTZ4			10 (7 wet and 3 dry)		
Peak West	FTZ5			10 (7 wet and 3 dry)		
Fitzroy River Mouth	FTZ6	✓	✓	10 (7 wet and 3 dry)		

\*Sites which were part of the MMP sampling design from 2005–2015

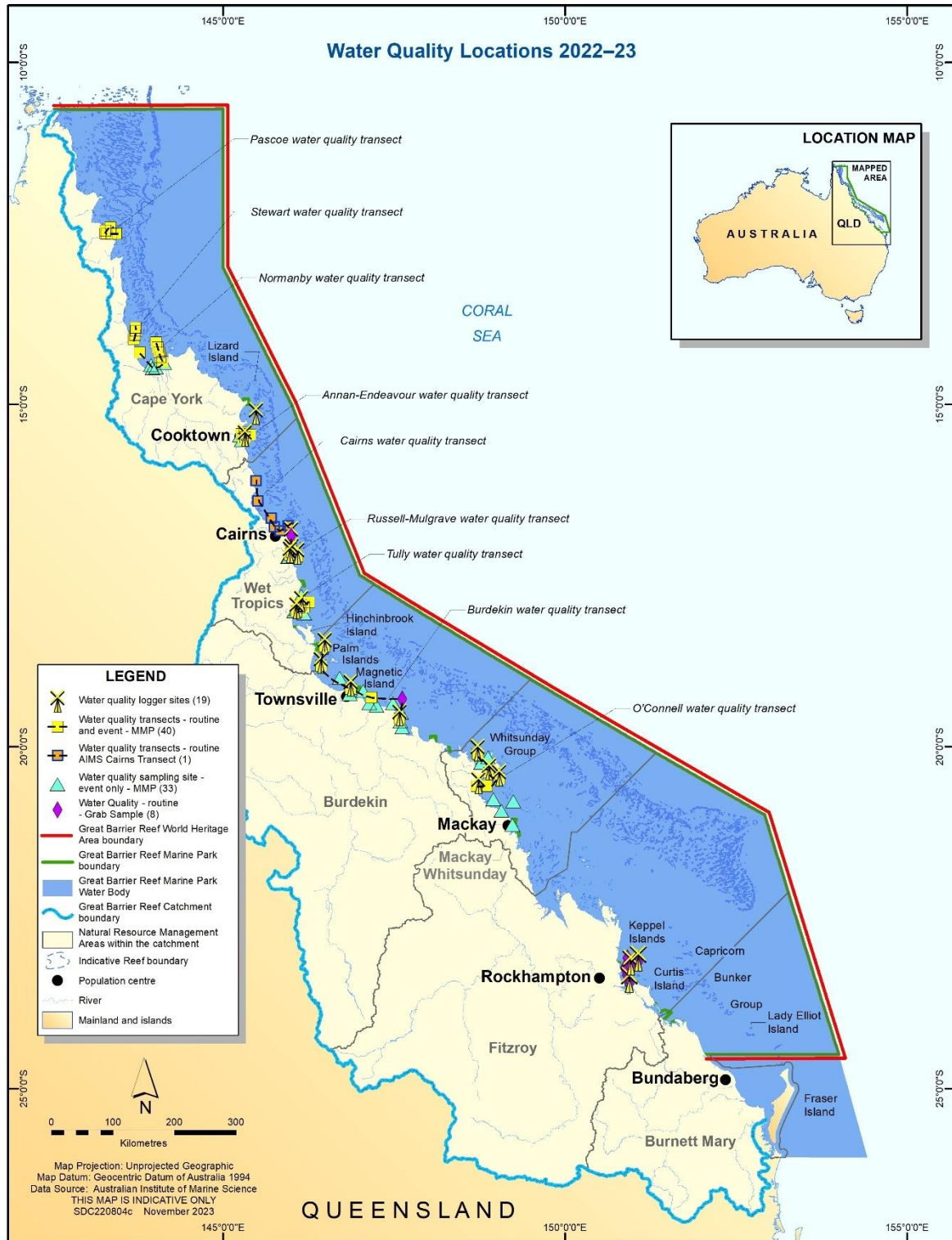

Figure 2-1 Site locations of the water quality monitoring sampled from 2015 onwards. The Fitzroy region water quality sites (prev. monitored 2005–2015 in MMPWQ) were re-instated through a partnership between AIMS and the Reef Trust Partnership in 2020.

## 2.2.2 Sample collection, preparation, and analysis (AIMS)

The following standard quality assurance protocols are followed for all water chemistry sampling performed by AIMS:

- PVC disposable gloves are worn by staff at all times during sample collection and manipulation. Before sampling, staff clean their hands thoroughly with fresh water. Grease, oils, soap, fertilisers, sunscreen, hand creams and smoking can all contribute to contamination.
- The sampling container and other sampling paraphernalia is well-rinsed with site water before sampling.
- The filling instructions and storage requirements (described in the following sections) are adhered to when conducting chemistry sampling.
- On each sampling run, the date, time and unique sample identification are recorded on the field datasheet. Each sampling kit for each site contains sets of sampling bottles and vials labelled with a unique alpha-numeric station name (the convention is for a three letter-three number code (e.g., WQQ001)).
- Any significant change of sampling conditions (i.e. weather and other factors which may influence the ability to collect samples) is noted in the comments section of the record sheet.

Vertical profiles of the water column are conducted using a Conductivity Temperature Depth (CTD) profiler. AIMS uses several Sea-Bird Electronics CTD profilers (SBE 19plus), which are fitted with additional sensors including fluorometers, transmissometers and Photosynthetically Active Radiation (PAR) sensors. Annual calibrations of the profiler instrumentation are carried out in Sea-Bird Electronics laboratories in the USA. These calibration values are included within the SBE configuration files. Pre-trip CTD checks are carried out at AIMS. These include checking the physical status of the sensors and cables and battery status.

Prior to deployment of the CTD profiler on board the boat, the CTD is secured to the hydrographic wire or line. Tygon tubing is removed from the CTD to allow flush water to drain from the conductivity-temperature cell and any protective caps are removed from the other sensors. To activate logging, the magnetic switch is moved to the “on” position and the CTD cage is lowered into the water sitting ~2 m below the surface. A three-minute soak of the CTD begins, to allow sensors to equilibrate and air bubbles to be flushed by the pump.

The CTD is then raised to ~0.2 below the surface and the profile is commenced at a rate of 0.5 – 1 m s<sup>-1</sup>. The CTD is sent to near bottom, ensuring it does not touch the seafloor, and retrieved to the surface where the switch is turned off. See Appendix A1 for further details on CTD cast procedures and details of data post-processing and storage. In all cases, the CTD must be deployed on the sunny side of the boat to avoid interference with light data from the boat shadow. The CTD must be held at the surface for three minutes before performing the downcast to allow for the stabilisation of the sensors. Secchi depth is determined at each station by a person not wearing sunglasses.

Immediately following the CTD cast, discrete water samples are collected from two depths through the water column (~0.5 m below the water surface and ~1 m above the seabed) with Niskin bottles. Duplicate sub-samples are taken from the Niskin bottles for analysis of dissolved inorganic nutrients [ $\text{NH}_3$ ,  $\text{NO}_2$ ,  $\text{NO}_3$ ,  $\text{PO}_4$ ,  $\text{Si}(\text{OH})_4$ ], total dissolved nitrogen (TDN), total dissolved phosphorus (TDP), dissolved organic carbon (DOC), CDOM, particulate nutrients (PN and PP), particulate organic carbon (POC), TSS, and Chl-*a*. Samples are also taken for laboratory salinity measurements using a high-precision salinometer (Appendix A2). Temperatures at each sampling depth are measured with reversing thermometers attached to the Niskins.

In addition to the ship-based sampling, water samples are collected by diver-operated Niskin bottles for validation of turbidity and fluorescence measurements by moored loggers. Samples for lab analysis of Chl-*a* and TSS are collected close to the deployed loggers and are processed for Chl-*a* concentration, TSS and salinity, using the same methods as those for the ship-based samples.

Samples for dissolved nutrient analysis are immediately filtered through a 0.45  $\mu\text{m}$  filter cartridge (Sartorius Minisart N) into acid-washed, screw-cap plastic test tubes, which are pre-rinsed twice with filtered site water. Dissolved inorganic nutrient ( $\text{NH}_3$ ,  $\text{NO}_2$ ,  $\text{NO}_3$ ,  $\text{PO}_4$ ) and total dissolved nutrient (TDN and TDP) samples are then stored frozen ( $-18^\circ\text{C}$ ) until subsequent analysis ashore. Samples for DOC analysis are filtered, acidified with 100  $\mu\text{L}$  of AR-grade HCl, and stored refrigerated ( $4^\circ\text{C}$ ) until analysis. Samples for  $\text{Si}(\text{OH})_4$  are filtered and stored refrigerated ( $4^\circ\text{C}$ ) until analysis. Samples for CDOM analysis are filtered through a 0.2  $\mu\text{m}$  filter cartridge (Pall-Acropak supor membrane) into acid-washed, amber glass bottles and stored refrigerated ( $4^\circ\text{C}$ ) until analysis (within 7 days of collection).

Inorganic dissolved nutrient [ $\text{NH}_3$ ,  $\text{NO}_2$ ,  $\text{NO}_3$ ,  $\text{PO}_4$ ,  $\text{Si}(\text{OH})_4$ ] concentrations are determined by standard wet chemical methods (Ryle *et al.* 1981) implemented on a segmented flow analyser after return to the AIMS laboratory (Appendix A3). Analyses of total dissolved nutrients (TDN and TDP) are performed using persulfate digestion of water samples (Valderrama 1981) (Appendix A3), which are then analysed for inorganic nutrient concentrations, as above.

DOC concentrations are measured by high temperature combustion ( $720^\circ\text{C}$ ) using a Shimadzu TOC-L carbon analyser. Before analysis,  $\text{CO}_2$  remaining in the sample water is removed by sparging with  $\text{O}_2$  carrier gas (Appendix A4).

CDOM samples are measured on a Shimadzu UV Spectrophotometer (UV-1900) equipped with 10-centimetre cells using Milli-Q water as a blank. Before analysis, samples are allowed to warm to room temperature ( $\sim 25^\circ\text{C}$ ) (Appendix A5).

Samples for POC, PN, PP and Chl-*a* are collected on pre-combusted ( $450^\circ\text{C}$  for 4 h) 25 mm diameter glass fibre filters (Whatman GF/F, pore size  $\sim 0.7 \mu\text{m}$ ). Before subsampling the sampling containers are thoroughly agitated to ensure particulates do not settle and skew results. Filters are wrapped in pre-combusted aluminium foil envelopes and stored frozen ( $-18^\circ\text{C}$ ) until analysis.

Concentration of PP is determined spectrophotometrically as inorganic phosphorus ( $\text{PO}_4$ ) (Parsons *et al.* 1984) after digesting the particulate matter in five per cent potassium persulfate (Appendix A6). The method is standardised using orthophosphoric acid and dissolved sugar phosphates as the primary standards.

The POC content of material collected on filters is determined by high temperature combustion ( $950^\circ\text{C}$ ) using a Shimadzu TOC-V carbon analyser fitted with a SSM-5000A solid sample module (Appendix A7). Filters containing sampled material are placed in pre-combusted ( $950^\circ\text{C}$ ) ceramic sample boats. Inorganic C on the filters (for example  $\text{CaCO}_3$ ) is removed by acidification of the sample with 2 M hydrochloric acid. The filter is then introduced into the sample oven ( $950^\circ\text{C}$ ), purged of atmospheric  $\text{CO}_2$  and the remaining organic carbon is combusted in an oxygen stream and quantified by infrared gas analysis. The analyses are standardised using certified reference materials (for example NCS DC73047).

PN is determined using a Shimadzu TN unit (model TNM-1) fitted in series to the aforementioned carbon analyser. After the carrier gas stream moves from the carbon detector it enters an ozone saturated reaction chamber where  $\text{NO}_2$  reacts with ozone. This reaction generates chemiluminescence, which is then measured using a chemiluminescence detector (Appendix A7). The analyses are standardised using certified reference materials (for example NCS DC73047).

Chl-*a* concentrations are measured fluorometrically using a Turner Designs 10AU fluorometer after grinding the filters in 90% acetone (Appendix A8) (Parsons, Maita, and Lalli 1984). The fluorometer is calibrated using a Chl-*a* standard from *A. nidulans* algae (Sigma-Aldrich C1644). The extract Chl-*a* concentrations are determined spectrophotometrically using the wavelengths and equation specified in (Jeffrey and Humphrey 1975). The solutions are then diluted and used to produce a standard curve matching the sample concentration range and of suitable concentration for use in the fluorometer.

Samples for TSS are collected on pre-weighed  $0.4\ \mu\text{m}$  polycarbonate filters (47 mm diameter, GE Water & Process Technologies), which are triple rinsed with Milli-Q water following sample filtration to remove any salts from the filter. TSS concentrations are determined gravimetrically from the difference in weight between loaded and unloaded filters after the filters have been dried for 72 hours at  $60^\circ\ \text{C}$  (Appendix A9).

### 2.2.3 Autonomous environmental water quality loggers (AIMS)

*In situ* autonomous water quality monitoring is undertaken using WET Labs Environmental Characterisation Optics (ECO) FLNTUSB Combination Fluorometer and Turbidity Sensors. The ECO FLNTUSB instruments perform simultaneous *in situ* measurements of chlorophyll fluorescence, turbidity, and temperature (Appendix A10).

Chlorophyll fluorescence measured *in situ* is dominated by the concentration of the Chl-*a* pigment, but also includes accessory chlorophyll pigments and some degradation products. Measurement of Chl-*a* from filtered water samples (described above) specifically measures the Chl-*a* from phytoplankton. To clarify the difference between measurements from filtered

water samples versus instrumental data, the *in situ* fluorescence measurements from loggers are referred to as 'chlorophyll' to distinguish them from direct water sampling measurements of 'Chl-*a*'.

The instruments are used in 'logging' mode and record a data point every 10 minutes for each of the three parameters; each data point is calculated as the mean of 50 instantaneous burst readings. Pre- and post-deployment checks of each instrument include measurements of the maximum fluorescence response and the dark count (instrument response with no external fluorescence, essentially the 'zero' point). Factory servicing and calibration checks are performed at the WET Labs facility in the USA after 12-18 months of in-water deployment time (Appendix A10).

After retrieval from the field locations, the instruments are cleaned and data downloaded and converted from raw instrumental records into measurement units ( $\mu\text{g L}^{-1}$  for chlorophyll fluorescence, NTU for turbidity, and  $^{\circ}\text{C}$  for temperature) according to the standard procedures of the manufacturer. Deployment information and all raw and converted instrumental records are stored in an Oracle-based data management system developed by AIMS. Records are quality-checked using time-series data editing software (WISKI<sup>®</sup>-TV, Kisters) and unreliable data caused by instrument problems removed (Appendix A11).

Instrument data are validated against concurrently collected water samples. The relationship between optically measured turbidity and TSS analysed on filters is relatively good (Figure 2-2), and the linear equation  $[\text{TSS (mg L}^{-1})] = 1.3 \times \text{FLNTUSB Turbidity (NTU)}$  has been used for conversion between these two variables. Though these relationships are valid it should be remembered that the two variables are measures of two different things that do not necessarily co-vary. Using this equation, the TSS trigger value in the Water Quality Guidelines of  $2.0 \text{ mg L}^{-1}$  (Great Barrier Reef Marine Park Authority 2010) translates into a turbidity trigger value of 1.5 NTU.

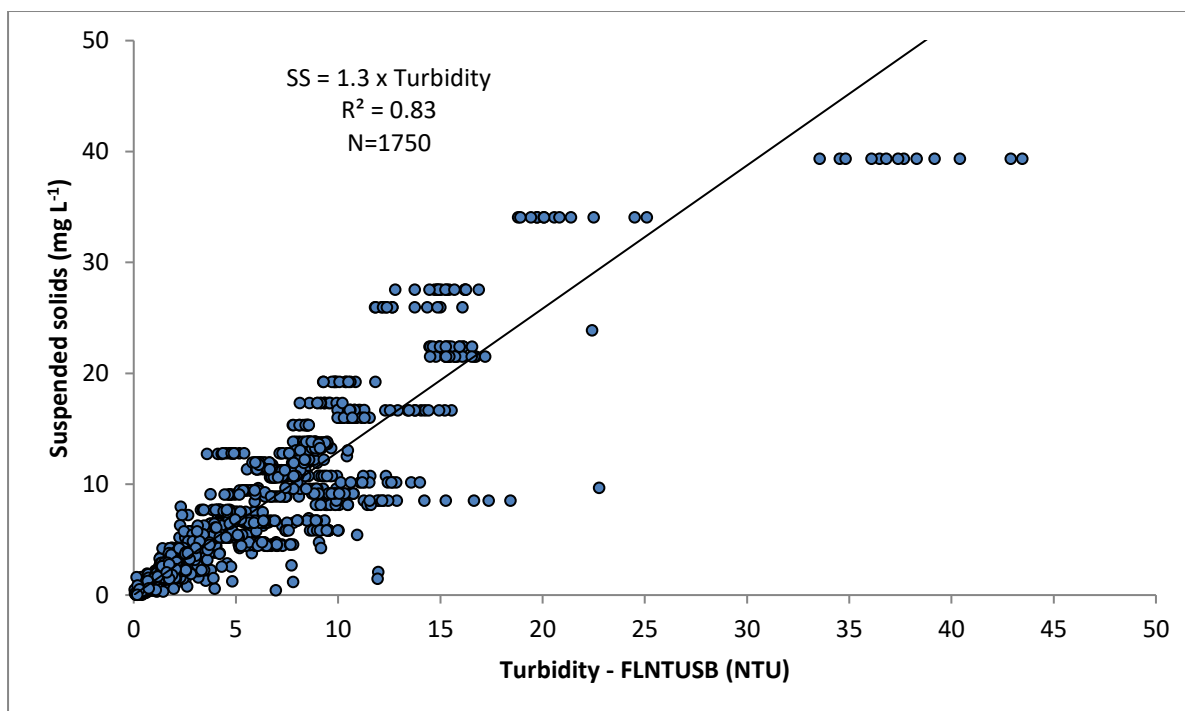

Figure 2-2 Correlation between instrument readings of turbidity (NTU) from field deployments of WET Labs Eco FLNTUSB loggers with values from concurrently collected total suspended solids (TSS) samples.

#### 2.2.4 Sample collection, preparation, and analysis (JCU and CYWP)

Sampling kits containing all sampling consumables (i.e. containers, filters, etc.) are prepared by AIMS and provided to partner organisations. Following sample collection, all samples and data sheets are returned to AIMS for analysis and databasing.

Methods of sampling are consistent with AIMS processes; however, some modifications have been made to sampling and storage procedures to allow for the equipment availability and transport of samples back to AIMS for analysis. Field processing procedures and sample storage requirements are listed in Table 2-2.

At each sampling station in the Wet Tropics and Burdekin regions, vertical profiles of water depth, temperature, salinity, dissolved oxygen, turbidity, and photosynthetically available radiation are taken with a SeaBird SBE-19Plus Conductivity Temperature Depth profiler (CTD). In Cape York, a CastAway CTD is used to collect vertical profiles of water temperature, salinity, and depth.

Water samples are collected from the same strata of the water column as AIMS samples (~0.5 m below the water surface and ~1 m above the seabed). Depending on the sampling vessel, partner organisations use 5 L Niskin bottles or may collect surface samples using an extended sampling pole with swing sampler and clean 500 mL bottle or a rinsed clean 10 L sampling container. Depth samples are collected using a rinsed 5 L Niskin bottle; the 'bottom' is determined by the depth sounder on the boat. Sub-samples are taken for different

water quality parameters (see Appendix A1). All water quality parameters are collected for all stations.

Dissolved nutrient, silica, and CDOM samples are collected from the sampling container with sterile 60 mL syringes using the same methods outlines above. All sampling tubes are placed in a clean plastic bag and stored on ice in an insulated container on the sampling vessel. Samples are then stored either at 4° C or frozen (see Table 2-2) prior to transport to the AIMS laboratory for analysis. DOC samples are frozen and the acid added prior to laboratory analysis at AIMS. The analysis methods are described in Appendix A3 and Appendix A5.

PN and PP samples are collected in sterile 2 L containers and stored on ice before being filtered on Whatman GF/F filter papers on return to shore-based facilities. The target filter volumes for POC and PN are 500 mL and PP are 250 mL. These volumes are varied for very turbid samples so as not to run off scale during analysis (i.e., if the Secchi depth is <3 m, the filter volumes for POC/PN are reduced by half). The filters are frozen and transported to the AIMS laboratory for analysis. The analysis methods are described in Appendix A7 (POC/PN) and Appendix A6 (PP).

Table 2-2 Summary of sampling protocols with identification of post-sampling procedures, laboratory containers, and storage techniques.

Water quality parameter	Field processing	Laboratory container	Storage following processing	Laboratory method
Dissolved Organic Carbon (DOC)	Filtered water sample (0.45 µm)	10 mL plastic tube	Acidification and stored at 4°C (AIMS) or un-acidified and frozen (JCU)	Appendix A4
Oxidised nitrogen (nitrate + nitrite: NO <sub>x</sub> )	Filtered water sample (0.45 µm)	10 mL plastic tube	Frozen	Appendix A3
Ammonium (NH <sub>3</sub> )	Filtered water sample (0.45 µm)	10 mL plastic tube	Frozen	Appendix A3
Total dissolved nitrogen (TDN)	Filtered water sample (0.45 µm)	10 mL plastic tube	Frozen	Appendix A3
Filterable reactive phosphorus (PO <sub>4</sub> )	Filtered sample (0.45 µm)	10 mL plastic tube	Frozen	Appendix A3
Total dissolved phosphorus (TDP)	Filtered sample (0.45 µm)	10 mL plastic tube	Frozen	Appendix A3
Silica	Filtered sample (0.45 µm)	10 mL plastic tube	Stored at 4°C	Appendix A3
Coloured Dissolved Organic Matter (CDOM)	Filtered sample (0.2 µm)	60 mL amber glass bottle	Stored at 4°C	Appendix A5
Particulate Organic Carbon (POC)	500 mL filtered sample (0.7 µm GF/F filter)	0.7 µm GF/F filter wrapped in aluminium foil	Frozen	Appendix A7
Particulate nitrogen (PN)	500 mL filtered sample (0.7 µm GF/F filter)	0.7 µm GF/F filter wrapped in aluminium foil	Frozen	Appendix A7
Particulate phosphorus (PP)	250 mL filtered sample (0.7 µm GF/F filter)	0.7 µm GF/F filter wrapped in aluminium foil	Frozen	Appendix A6
Chlorophyll- <i>a</i> (Chl- <i>a</i> )	100 mL filtered sample (0.7 µm GF/F paper)	0.7 µm GF/F filter wrapped in aluminium foil	Frozen	Appendix A8
Total suspended solids (TSS)	1000 mL filtered onto pre-weighed (0.4 µm) 47 mm polycarbonate filter	0.4 µm polycarbonate filter in glass scintillation vial	Stored at 4°C	Appendix A9
Salinity	Unfiltered sample (250 mL)	250 mL plastic bottle	Stored at 4°C	Appendix A2

TSS samples are collected in pre-rinsed 1000 mL plastic containers using a well mixed 10 L container. Each container is rinsed at least once with the sample water, taking care to avoid any contact with the sample (gloves are worn at all times). Samples are stored on ice on the sampling vessel. Once the vessel has returned to shore, the TSS samples must be filtered within 24 hours of collection. Following filtration, frozen filters are transported to AIMS for analysis. The analysis methods are described in Appendix A9. For salinity samples, unfiltered water is stored in 250 mL bottles and stored on ice on the sampling vessel then transported to AIMS for analysis (see Appendix A2 for analysis methods). Chl-a samples are filtered through a 25 mm diameter GF/F filter paper held with a plastic syringe filter holder attached to the syringe. 100 mL of sample is filtered and then air is passed through the filter holder (using the syringe) to remove any excess water from the filter paper. The filter paper sample is then folded, wrapped in aluminium foil, labelled with the sample number and frozen, then transported to AIMS for analysis. The analysis method for the Chl-a samples is provided in Appendix A8.

### **2.2.5 Sample collection, preparation, and analysis: wet season flood events (JCU and CYWP)**

Event response sampling is conducted in addition to routine wet season sampling. The AIMS laboratory organises a flood sampling kit for each site that has the unique identifier for all samples. Samples are collected at the fixed routine sites and at the reactive flood plume sampling sites, and the parameters measured and sample collection procedures are identical to those described for the routine program. The event sampling is triggered when the downstream river flow gauge levels approach or exceed the 'moderate flood level' and if weather sea state conditions are suitable for sampling. The river flood levels are regularly monitored on the Bureau of Meteorology website ([http://www.bom.gov.au/qld/flood/rain\\_river.shtml](http://www.bom.gov.au/qld/flood/rain_river.shtml)) and include the gauges 'Burdekin R at Inkerman Br' (Burdekin River), 'Tully R at Euramo' (Tully River), 'Mulgrave R and Peets Bridge' and 'Russell R at Bucklands' (Russell-Mulgrave River), 'O'Connell R at Stafford Crossing' (Proserpine/O'Connell Rivers), 'Pioneer R at Dumbleton TW' (Pioneer River), Annan R at Beesbike, Normanby R at Kalpowar, Stewart R at Telegraph Road, and Pascoe R at Garroway Creek (Table 2-1).

Extra samples may also be collected depending on the extent of the plume depending on *in situ* salinity measurements. The majority of extra samples are collected inside the visible area of the plume, although some samples are taken outside the edge of the plume for comparison purposes. Flood event sampling is conducted in the focus areas but may also be extended to other regions in large events, such as the Fitzroy River in 2016–17 with the high river flow associated with cyclone Debbie.

The timing of sampling is dependent on the type of event and how quickly boats are mobilised. Sampling in flood plumes requires rapid response sampling protocols as a detailed pre-planned schedule is not possible due to the unpredictability of the river flood events. The need for a responsive, event-driven sampling strategy to sample plumes from flowing rivers is essential to capture the high flow conditions associated with these rivers (Wheatcroft and Borgeld 2000).

## 2.3 Data management

Data management practices are a major contributor to the overall quality of the data collected; inappropriate data management can lead to errors and lost data and can reduce the value of the MMP data. Several specific data systems have been developed for the MMP water quality monitoring to improve data management procedures and reduce the likelihood of human error (details on these are in Appendix A11). Data from the AIMS MMP inshore water quality monitoring and monitoring by JCU, CYWP and supplementary sampling by Vision Environment are stored in a custom-designed data management system in Oracle 11g databases to allow cross-referencing and access to related data. Once data are uploaded into the Oracle databases after the QAQC and validation processes, they are consolidated via Oracle views (see Appendix A11).

It is AIMS policy that all datasets collected have an associated metadata record. The metadata record is created using a Metadata Entry System (also known as the AIMS Data Catalogue) where the metadata is in the form of ISO19139.MCP XML. This is the chosen format for many agencies across Australia and the international community that deal with spatial scientific data. You can visit the AIMS Data Explorer at:

<https://apps.aims.gov.au/metadata/search>. The parent metadata record for the MMP is located here: <https://apps.aims.gov.au/metadata/view/2b2aa4e4-1368-49e0-8b25-1559ee297854>.

Specific child metadata records for MMPWQ datasets are listed below:

- Physico-chemical and nutrient database (containing all dissolved and particulate nutrient data, including data from JCU and CYWP): <https://apps.aims.gov.au/metadata/view/a5a02dc8-16b4-4b50-abad-af4a1c1e9c49>
- FLNTU logger database (containing all fluorescence/turbidity measurements from AIMS' ECO FLNTUSB loggers): <https://apps.aims.gov.au/metadata/view/8a698de1-3fbf-48a5-b068-358b07aad35c>
- Salinity/temperature time-series database (containing salinity/temperature data from AIMS' SBE37 loggers): <https://apps.aims.gov.au/metadata/view/351d44f5-6888-45fc-ac46-44ddb623bf1>
- CTD database (containing all AIMS' vertical cast data from CTD instruments): <https://apps.aims.gov.au/metadata/view/acad78d1-e235-45e6-8f27-0a00184e2ca9>

For all samples, station description and details (for example geographical position, date, time, sampling depth, local depth, weather, surface water temperature and comments) are recorded on weatherproof field datasheets. All JCU, CYWP, and Vision datasheets are scanned and sent to AIMS while the original copies are stored by the relevant partners. All water samples and filters are labelled with unique sample identifiers. Details from field datasheets are entered into the AIMS Field Data Entry System database. Data are independently checked after entry into the database.

### 3 Remote sensing and modelling of the Reef water quality and river flood plumes

Caroline Petus<sup>1</sup>, Dieter Tracey<sup>2</sup>, Jane Waterhouse<sup>1</sup>, Severine Choukroun<sup>1</sup>, Cassandra James<sup>1</sup>, Stephen Lewis

<sup>1</sup> James Cook University, <sup>2</sup> Great Barrier Reef Marine Park Authority

#### 3.1 Introduction

This component of the MMP provides remotely sensed information during the wet seasons (December to April), capturing river flood plumes and resuspension events. It assesses frequencies and composition of Reef optical water types and provides spatial information on the exposure and potential risk of coral reefs and seagrass meadows to river plumes, sediment resuspension and land-sourced pollutants.

There have been several methods within the flood plume program to characterise, map and monitor flood events in the Reef over the last 20 years (e.g., Devlin *et al.* 2015). These techniques and their resulting products evolved in complexity with time, from basic aerial photography in combination with *in situ* monitoring, to the application of advanced regional parameterised ocean colour algorithms (e.g. Brando *et al.* 2010; Brando *et al.* 2012), to the analyses of ocean colour products and optical water type maps correlated with *in situ* water quality gradients (Petus *et al.* 2019; Devlin *et al.* 2015). Current work focuses on improving the integration between satellite water colour information and field water quality data sampled in inshore waters during the wet season (including plume waters) (Petus. *et al.* 2014a; Álvarez-Romero *et al.* 2013; Collier *et al.* 2014; Petus *et al.* 2016; Petus *et al.* 2018). Greater integration with the eReefs marine model is also becoming increasingly important.

Optical water type maps of the Reef have been produced and analysed for the last 20 years (2002-2022), with the MODIS-Aqua sensor being the main source of satellite information between 2002 and 2020. MODIS true colour imagery were processed and reclassified to six distinct colour classes defined by their colour properties using a “wet season (W) colour scale” specifically developed for the Reef (Alvarez-Romero *et al.* 2013) (Figure 3-1a). The six colour classes were regrouped into three “wet season water types (Primary, Secondary and Tertiary)” and the marine water type. These water types are characterised by different concentrations of optically active components (TSS, CDOM and Chl-*a*) and representing typical colour and water quality gradient encountered in the Reef during the wet season (December to April). However, MODIS sensors were ageing, and the quality of the MODIS imagery was declining.

Since 2020, the Sentinel-3 Ocean Land Colour Instrument (OLCI) and Forel-Uie (FU) colour scale were implemented in the MMP for the continuous mapping of Reef water types (Petus *et al.* 2019). The FU colour scale is an historical colour scale global standard to determine the colour and classifies worldwide bodies of water (Novoa *et al.* 2013). It is composed of 22 colours; going from indigo blue to cola brown, and is applicable for all natural waters (inland, estuarine, inshore and offshore) and all environmental conditions, including wet and dry

season conditions (Wernand *et al.* 2012, 2013; Van der Woerd *et al.* 2016; Van der Woerd and Wernand, 2018).

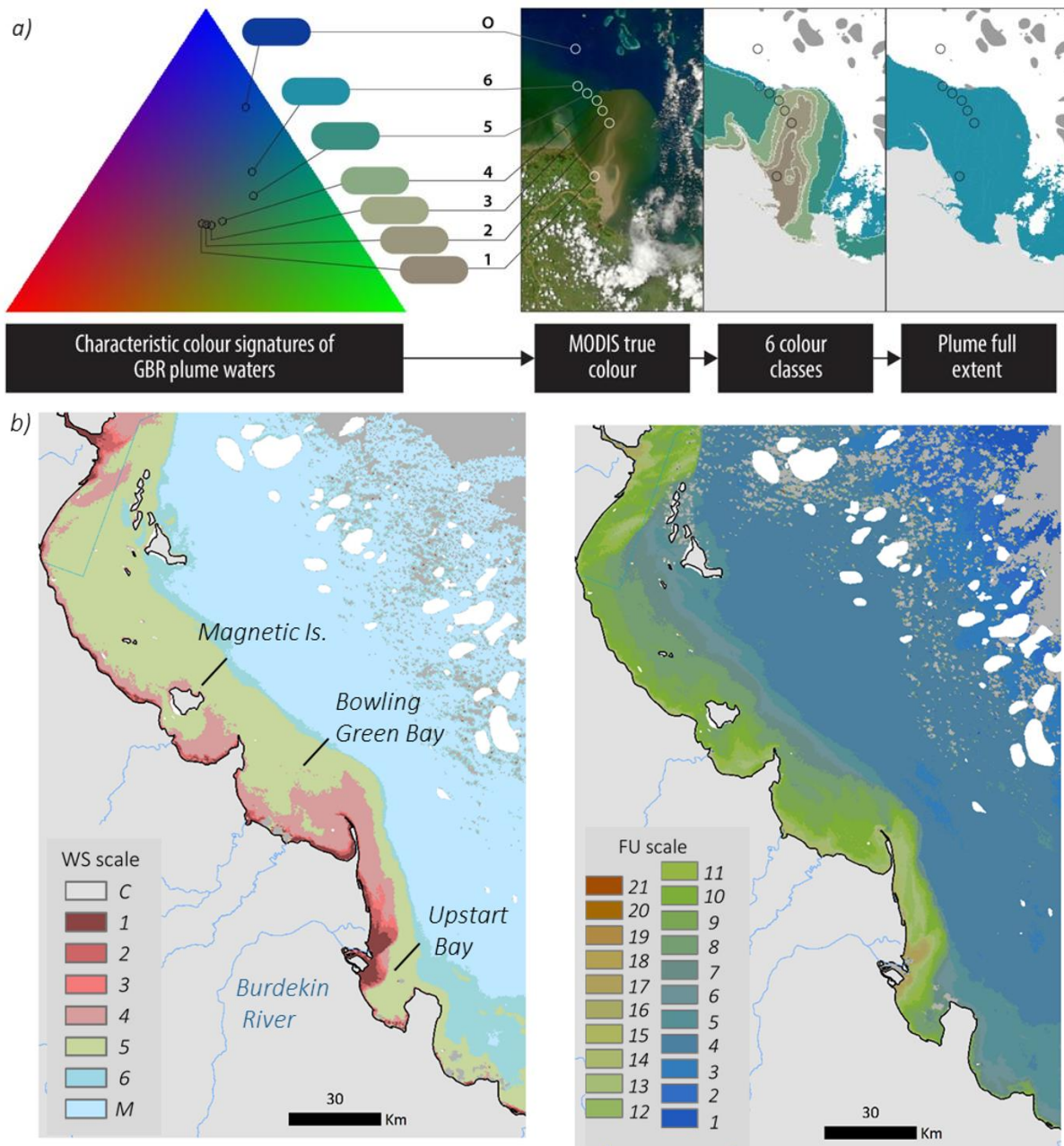

Figure 3-1 Triangular colour plot showing the characteristic colour signatures of the wet season water types in the Red-Green-Blue (RGB or true colour) space. Álvarez-Romero *et al.* (2013) developed a method to map these characteristic coastal water masses in the Reef using a supervised classification of MODIS true colour data (modified from Devlin *et al.* 2015). b) Illustration of the very similar colour patterns between the (left) MODIS wet season and (right) Sentinel-3 Forel-Ule colour class maps: Burdekin River plume, 14 March 2018.

MODIS-Aqua WS and Sentinel-3 FU colour class maps showed very similar patterns over the 2017-18 wet season in a case study focusing on Wet Tropics and Burdekin regions of the Reef (Petus *et al.* 2019 and Figure 3-1b). Since 2020, Reef water types maps are defined in the MMP by grouping the FU colour classes 1–3 (equivalent to marine waters in the WS colour scale), FU colour classes 4–5 (equivalent to the Tertiary water type or colour class 6 in the WS colour scale), FU colour classes 6–9 (equivalent to the Secondary water type or colour class 2 in the WS colour scale) and FU $\geq$ 10 (equivalent to the Primary water type or colour classes 1-4 in the WS colour scale), as defined in Petus *et al.* (2019) and in Table 3-1.

In the 2021–22 report (Moran *et al.* 2023), the water type (WT) terminology was furthermore modified to: Reef WT1, WT2, WT3, and WT4 instead of Primary, Secondary, Tertiary, and marine wet season water types. This change was made in response to recognition that the previous terminology may be misleading and systematically implied the presence of flood plume waters, while the Reef WT1 (Primary waters) may also represent sediment resuspension in shallower parts of the Reef lagoon, and the Reef WT3 (tertiary waters) may represent oceanographic processes such as upwelling or sediment resuspension around reefs and islands (Table 3-1). The classification of four Reef water types allows mapping of a broad grouping of water type characteristics with different colours, concentrations of optically active components (TSS, CDOM, and Chl-*a*), water quality indicators (e.g., nutrients levels; Devlin *et al.* 2015; Petus *et al.* 2019), and light attenuation levels (Petus *et al.* 2018) typically found in the Reef during the wet season (Table 3-1). These characteristics vary the potential impact on the underlying ecological systems. In summary:

- The brownish Reef WT1 (FU  $\geq$  10, equivalent to Primary water type) represents turbid waters from river flood plumes, and also sediment resuspension in the shallower parts of the Reef;
- The greenish Reef WT2 (FU 6–9, equivalent to the Secondary water type) represents the less turbid parts of flood plumes enriched in Chl-*a* and fine sediment. It is usually found in the inshore to mid-shelf regions of the Reef;
- The greenish-blue Reef WT3 (FU 4–5, equivalent to the Tertiary water type) represents waters with suspended sediment concentrations slightly above ambient conditions and high light penetration typically found in the outer areas of river flood plumes. It can also represent oceanographic processes such as upwelling or the fine sediment resuspension around reefs and islands; and
- The blueish Reef WT4 (FU 1–3) represents ambient waters with high light penetration and negligible concentrations of optically active water quality constituents.

Table 3-1 Description of the Sentinel-3 Reef water types (WT) and corresponding Forel-Ule (FU) colour classes (and comparison with MODIS wet season (WS) water types). Mean long-term (2004–2023) concentrations of water quality parameters ( $\pm$  standard deviation) across the Reef water types were updated in 2023 and are indicated in the right column (modified from Petus *et al.* 2019 and Waterhouse *et al.* 2018).

Reef water types	FU and WS colour classes	Description	Mean long-term (2004–23) concentrations of water quality parameters
WT1 (prev Primary)	FU $\geq$ 10 (WS1–4)	Brownish to brownish-green turbid waters typical of inshore regions of the Reef that receive land-based discharge and/or have high concentrations of resuspended sediments during the wet season. In flood conditions, this water type typically contains high sediment and dissolved organic matter concentrations resulting in reduced light levels. It is also enriched in coloured dissolved organic matter and phytoplankton concentrations and has elevated nutrient levels.	Secchi: $2.1 \pm 2.1$ m TSS: $17.4 \pm 44.1$ mg L <sup>-1</sup> Chl-a: $1.5 \pm 2.2$ $\mu$ g L <sup>-1</sup>
WT2 (prev Secondary)	FU6–9 (WS5)	Greenish to greenish-blue turbid water typical of coastal waters with colour dominated by phytoplankton (Chl-a), but also containing dissolved organic matter and fine sediment. This water body is often found in open coastal waters of the Reef as well as in the mid-shelf where relatively high nutrient availability and increased light levels due to sedimentation favour coastal productivity (Bainbridge <i>et al.</i> , 2012).	Secchi: $4.6 \pm 2.8$ m TSS: $4.6 \pm 7.0$ mg L <sup>-1</sup> Chl-a: $0.6 \pm 0.7$ $\mu$ g L <sup>-1</sup>
WT3 (prev Tertiary)	FU4–5 (WS6)	Greenish-blue waters corresponding to waters with slightly above-ambient suspended sediment concentrations and high light penetration typical of areas towards the open ocean. This water type includes the outer areas of river flood plumes, fine sediment resuspension around reefs and islands and oceanographic processes such as upwelling. Reef WT3 waters are associated with low land-based contaminant concentrations and the ecological relevance of these waters is likely to be minimal although not well researched. The Type III areas have a low magnitude score in the Reef exposure assessment.	Secchi: $8.2 \pm 4.1$ m TSS: $2.3 \pm 3.9$ mg L <sup>-1</sup> Chl-a: $0.4 \pm 0.4$ $\mu$ g L <sup>-1</sup>
WT4 (previously marine)	FU1–3 No number	Blueish marine waters with high light penetration.	Secchi: $11.0 \pm 4.8$ m TSS: $1.8 \pm 3.5$ mg L <sup>-1</sup> Chl-a: $0.5 \pm 0.9$ $\mu$ g L <sup>-1</sup>

Several monitoring products are derived from the water type maps and water quality data. They are summarised in

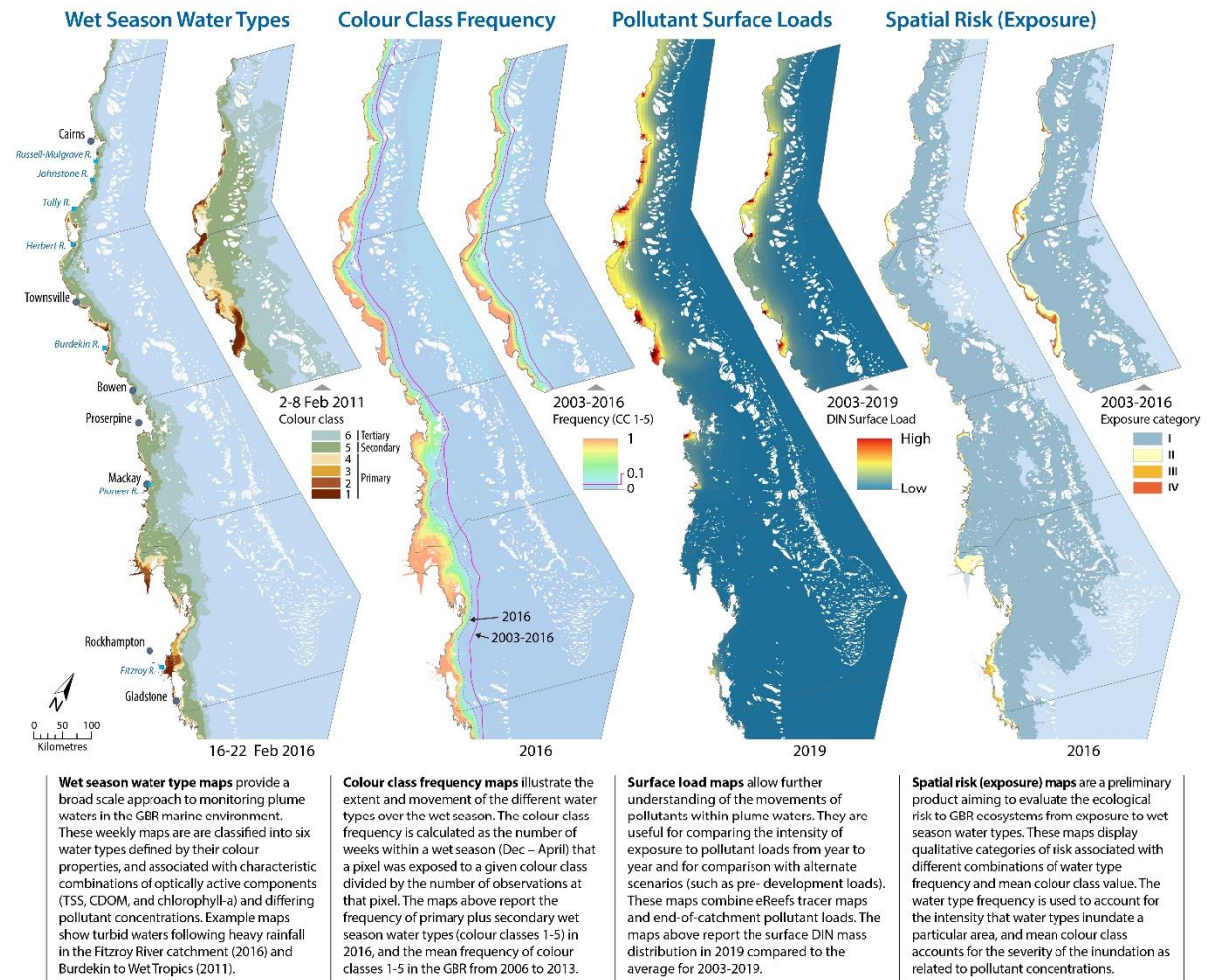

Figure 3-2 and aim to:

- Map water types and water quality gradients during the wet season and assess the extent and movement of river flood plumes during high flow conditions;
- Characterise the composition of the Reef wet season water types (boxplot of long-term TSS, Chl-a, CDOM, DIN, DIP, PP and PN concentrations and Secchi values);
- Identify where mean long-term concentrations of TSS, Chl-a, PP, and PN may be above wet season GVs. Wet season GVs for the whole of the Reef (hereafter Reef-wide GVs) are derived from (De'ath and Fabricius 2008); and
- Assess the exposure of coral reefs and seagrass ecosystems to potential risk from river plumes, sediment resuspension and land-sourced pollutants.

These products are used to illustrate wet season conditions for every wet season and to compare seasonal trends with longer-term or reference trends in water composition, including long-term conditions, typical wet year and dry year conditions and conditions over a documented recovery period for coral reefs. Available satellite data are biased toward non-cloudy days and may underrepresent poor water quality in regions of higher rainfall and cloudiness like the Wet Tropics and Cape York. However, they provide a unique large-scale and long-term view of the Reef that is not available using water quality data only.

Maps representing the distribution of surface loads also provide further understanding of the movements of pollutants from river discharge. The maps combine eReefs tracer maps and end-of-catchment pollutant loads to represent the distribution of wet season loads in the Reef. The maps are useful for comparing the intensity of exposure to pollutant loads from year to year and for comparing pre-development loads and current loads to present anthropogenic surface loads.

### **3.2 Methods**

TropWATER collects information on the movement of flood plumes across the Reef and quantifies the exposure of Reef ecosystems to different wet season water quality conditions using satellite imagery.

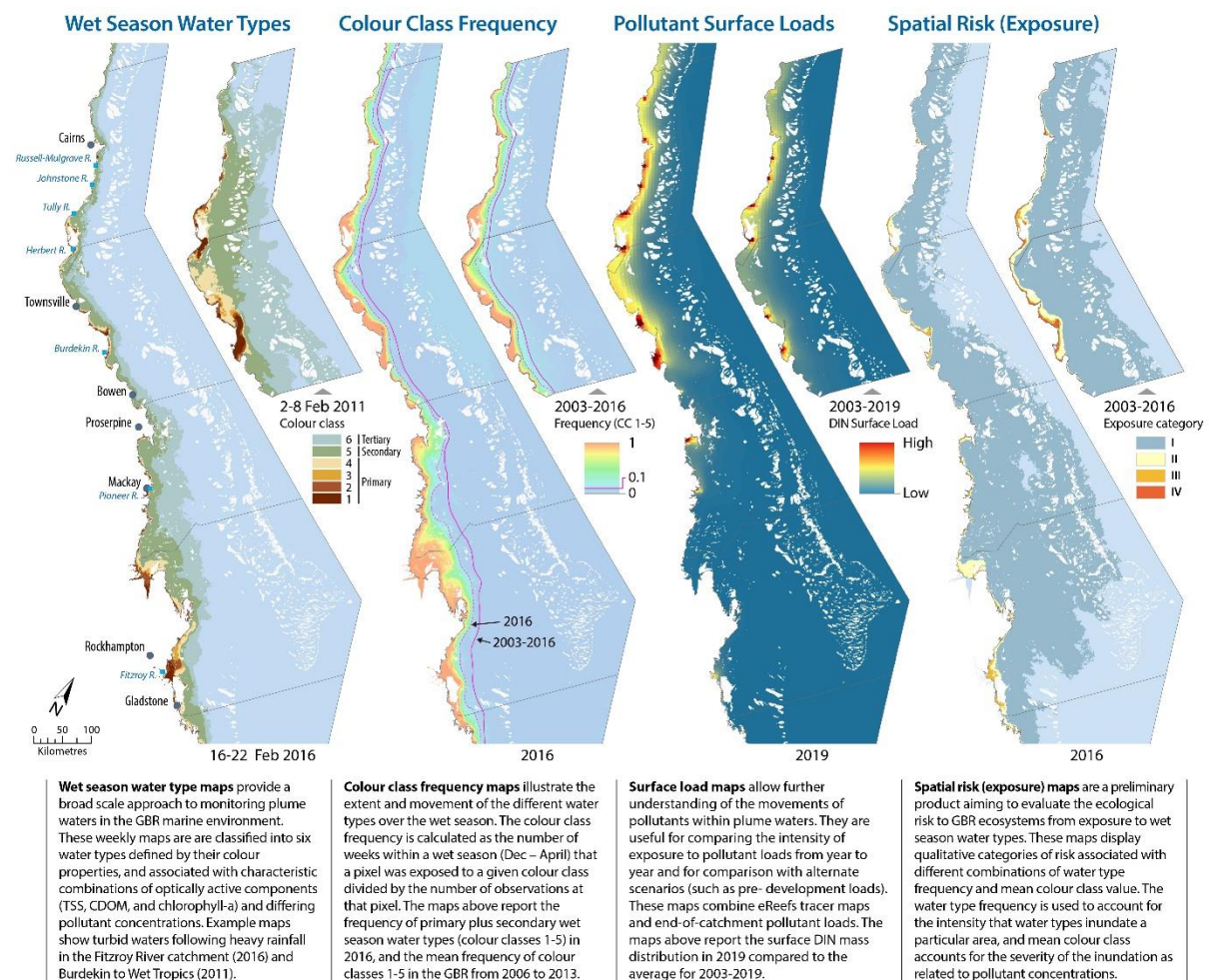

Figure 3-2 Summary description of the wet season water quality products.

### 3.2.1 Optical satellite data

- **MODIS true colour imagery (2002–2020)**

The Terra and Aqua satellite platforms were launched in 1999 and 2002 respectively, by the National Aeronautics and Space Administration (NASA). They carry the MODIS instrument, a visible imaging radiometer which provides regular coverage (twice per day) of the GBR coastal waters. MODIS-Aqua data were operationally used in the MMP from 2002–2020 (GBRMPA, 2021), and MODIS Terra only occasionally, as the radiometric quality of the MODIS-Terra ocean colour bands is significantly worse and cross-calibrated to MODIS Aqua.

MODIS true-colour images for 2011 (very wet), 2016 and 2017 (dry) years, and from 2018 to 2020 were processed by the Bureau of Meteorology, while all other years were processed in-house by TropWATER. MODIS Level-0 imagery was downloaded on the Ocean Colour Web (URL: <https://oceancolour.gsfc.nasa.gov/>) and processed to true colour imagery using SeaDAS 7.4 and following processes summarised in Table 3-2 (GBRMPA, 2021). The method assumed that fully accurate atmospheric corrections are less crucial for turbid (case

2) Reef flood waters than it would be for clear (case 1) waters, and MODIS true-colour images were produced using Rayleigh corrected reflectance of MODIS bands 1, 4, and 3 (without an aerosol removal step).

Table 3-2 Keywords and justification used in SeaDAS 7.4 to process MODIS true colour images of the Great Barrier Reef.

Step	Term	Description
Step 1: modis_GEO.py	terrain correction	Given the area of interest is the ocean, terrain correction is not used (in modis_GEO.py the --enable-dem flag is not used)
Step 2: modis_L1B.py	look up table (LUT)	The arguments “-l 6.1.33.4_OC -d /short/er8/packages/seadas/7.0/ocssw/run/var/modisa/cal/EVAL” are passed to use the 6.1.33.4_OC L1B look up table.
Step 3: l1mapgen	Calibration table	The msl12_defaults.par was updated to use the xcal_modisa_axc39d cross-calibration files.
	Atmospheric correction	The atmcor keyword was set to “on” to make sure that the Rayleigh correction was applied.
	resolution	The resolution keyword was set to “250” to use band 1 as input.

The output of the SEADAS l1mapgen tool is a true colour image in GeoTIFF format. Where multiple granules are required to cover the region of interest, the true colour GeoTIFF images are combined using the imagemagick convert tool. During this process, the GeoTIFF location tags are removed. They are added back to the GeoTIFF image via the use of the GDAL gdalcopyproj.py script. The argument and keywords used are shown in Table 3-2.

True colour images have a spatial resolution of 500 m × 500 m and combine three ocean bands (i.e. red, green and blue, RGB) in the visible spectrum. They have a daily temporal resolution and cover the entire Reef area (extreme coordinates: -10.5, -27.0, 142.3 and 154.0). The true colour images cover the wet season period (i.e. December to April, inclusive) since December 2002–April 2003 up to December 2019–April 2020 and were processed with the wet season Satellite Toolbox to produce MODIS-Aqua wet season water type maps of the study area following the processes outlined below. Processed MODIS data were stored in external media and also at the national Research Data Services, which is part of Research Data Australia (<https://researchdata.and.s.org.au/>).

- **Sentinel-3 OLCI imagery (2020–present)**

The Sentinel-3A and 3B platforms were launched in February 2016 and April 2018 respectively by the European Space Agency (ESA). They carry the OLCI, a visible imaging radiometer which provides a daily coverage of the GBR coastal waters since 2018 (two to three times a week coverage since 2016). Sentinel-3 OLCI Level-2 imagery (hereafter, Sentinel-3) of the study area is downloaded on the EUMETSAT data centre online ordering client (URL: <https://www.eumetsat.int/ordering-client>) which provide OLCI Level-2 data for the entire earth. Sentinel-3 data are atmospherically corrected and are processed with the FU Satellite Toolbox implemented in SNAP (Van der Woerd *et al.* 2016; Van der Woerd and Wernand, 2018) to produce S3-FU maps of the study area following steps described below.

### 3.2.2 Colour classifications

#### Supervised classification of MODIS-Aqua imagery using the Wet Season Colour Scale

Previous methods used daily MODIS true colour imagery acquired from the NASA Ocean Colour website.

A set of spatial analyses (Python, ArcGIS) based on supervised classification of spectrally enhanced true colour images was used to classify ‘turbid’ waters, including river flood plumes and resuspension events, and ‘non-turbid’ areas in the Reef, focusing on the wet season period. The true-colour images are spectrally enhanced (from red-green-blue to hue-saturation-intensity colour system) and classified to six colour categories through a supervised classification using spectral signatures from typical wet season water masses types (including river plumes) in the Reef. The six colour classes are further reclassified into three wet season water types (Primary/WT1, Secondary/WT2 and Tertiary/WT3) corresponding to the three wet season water types, as described above and defined originally by Devlin and Schaffelke 2009 and Devlin *et al.* 2012. This supervised classification was used to classify daily MODIS images and create an historical database of daily MODIS wet season water type maps for wet season between 2002 and 2020.

#### Classification of Sentinel-3 OLCI imagery using the Forel-Ule Colour Scale

For the 2022–23 report, Reef water type maps were produced using daily Sentinel-3 OLCI Level 2 (hereafter, Sentinel-3 or S3) imagery reclassified to 21 distinct colour classes defined by their colour properties and using the FU colour classification scale.

The FU colour scale comparator is a 21-level colour classification system based on human visual comparison with glass encased colour standards. It was developed in the late 19th century and can be used worldwide, with any natural water body (marine, coastal, estuarine and lake). A remote sensing toolbox has been recently developed to classify water bodies into FU categories from satellite ocean colour imagery through European ECFP7 funding and the Citclops project (URL: <http://www.citclops.eu/home>). It has been recently implemented in the Sentinel-3 Toolbox, which is built on the Sentinel Application Platform (SNAP, URL: <https://step.esa.int/main/toolboxes/snap/>). The FU satellite algorithm converts satellite normalised multi-band reflectance information into a discrete set of FU numbers using uniform colourimetric functions. The derivation of the colour of natural waters is based on the calculation of Tristimulus values of the three primaries (X, Y, Z) that specify the colour stimulus of the human eye. The algorithm is validated by a set of hyperspectral measurements from inland, coastal and marine. Technical details about the FU scale algorithm, including detailed mathematical descriptions, are presented in Novoa *et al.* (2013), Van der Woerd and Wernand (2015, 2016, 2018), and Wernand *et al.* (2013).

A set of scripts and special analyse (Python, ArcGIS) was developed for the MMP and is used to run the FU Satellite Toolbox and process daily sentinel-3 FU maps in a GeoTIFF format. Where multiple granules are required to cover the region of interest, the true colour GeoTIFF images are then combined using a Python script in ArcMAP 10.6.1. The Forel Ule images have a spatial resolution of 300 m x 300 m and a daily temporal resolution. They

cover the entire Reef area (extreme coordinates: -10.5, -27.0, 142.3 and 154.0) and the wet season period (i.e. December to April, inclusive) since December 2020.

### 3.2.3 Production of weekly wet season water type maps

Weekly wet season water type composites are created to minimise the image area contaminated by dense cloud cover and intense sun glint (Álvarez-Romero *et al.* 2013). The minimum WS or maximum FU value of each pixel/week is used to keep the colour class with the highest turbidity level for each wet season week i.e., assuming the colour classes represented a gradient in turbidity:

- WS CC1 > CC2 > ... > CC6 or (for the MODIS imagery)
- FU22 > FU21 > FU20 > ... > FU1 (for the Sentinel imagery).

All weekly composites are automatically cleaned. The aim of cleaning is to minimise the image area contaminated by dense cloud cover and intense sun glint, and to remove shallow water interference around reefs. In all cases the effect of these phenomena can be that offshore waters are misclassified as, for example, Primary/WT1 waters (CC 1–4 or FU  $\geq$  10). To minimise these effects an automated process is applied to the rasters that has the effect of sequentially infilling contiguous water-type areas one colour class at a time from the Marine (ambient ocean water) inwards towards the coast. This processing is performed using Python 2.7.3 (Python Software Foundation 2012) and ArcGIS 10.7 (ESRI, 2019). Infilling is achieved using the following steps: 1) Raster to Polygon conversion (not simplified), 2) Union (no gaps) then 3) removal, using Erase, of an external polygon, and 4) Polygon to Raster conversion. This process generates a separate raster mask (values 1 or 0) for each colour class, and the final cleaned raster is created by adding the component raster masks. Whilst this process is effective at removing noise offshore it can occasionally have the effect of removing areas of turbid coastal and plume water if they are not directly connected to the coast. To counter this, a final step is included in the cleaning process whereby, using Con (Spatial Analyst), waters classified as:

- CC1 and CC2 (i.e. values < 3) in the cleaned raster are replaced with pixels of CC1 and CC2 in the original raster (MODIS imagery), and
- FU classes  $\geq$  10 in the cleaned raster are replaced with pixels of FU classes  $\geq$  10 in the original raster (Sentinel imagery).

Thus, pixels adjacent to the coast that are classified as highly turbid water are kept and pixels within otherwise contiguous water types offshore are removed. The script is occasionally re-run using a different value than 3 in cases where moderately turbid inshore waters have evidently been removed during the cleaning process but that was not required this year. Extra cleaning steps can sometimes be applied to weeks with large residual noise (manual cleaning or exclusion of very noisy day images from the database) if needed.

The four distinct Reef water types are then defined by grouping the FU colour classes 1–3 (Reef WT4, equivalent to marine waters in the WS scale), FU colour classes 4–5 (reef WT3, equivalent to Tertiary water type), FU colour classes 6–9 (Reef WT2, equivalent to

Secondary water type) and  $FU \geq 10$  (Reef WT1, equivalent to water type (Reclassify Tool, ArcMap 10.6).

### 3.2.4 Production of annual, multi-annual and typical Wet and Dry wet season water type maps

**Seasonal frequency map:** Weekly wet season water type composites are overlaid in ArcGIS (i.e., presence/absence of one wet season water type) and normalised, to compute each year a seasonal normalised frequency maps of occurrence of wet season water type. Pixel (or cell) values of these maps range from 1 to 22; with a value of 22 meaning that one pixel has been exposed 22 weeks out of 22 weeks of the wet season. Annual frequency maps are normalised (0–1) and overlaid in ArcGIS to create multi-annual normalised frequency composites of occurrence of wet season water types.

**Reference maps:** Multi-annual reference composites are calculated using the seasonal MODIS (2002–03 to 2019–20) and Sentinel (2020–21 to 2022–23) water type maps over different time frames, including (i) a long-term (using data available since 2002–03) period and (ii) a typical recovery period for Reef corals (2011–12 to 2016–17). Composite frequency maps are also produced to represent typical wet year and dry year conditions. To account for broad-scale spatial variability in wet season river flows, wet- and dry-year maps are first produced separately by averaging frequency maps from the four wettest and driest years in each NRM region. Wet and dry years are defined using the total catchment discharge in the NRM region (Table 3-3).

Table 3-3 Wettest and driest years used to compute the typical wet and typical dry composite frequency maps in each NRM region. All years are in the top/bottom quartiles, total catchment discharge in the NRM region except 2005 and 2007 for Cape York which are under the long-term median.

Region	Wet years				Dry years			
<b>Cape York</b>	2021	2006	2011	2019	2003	2016	2005	2007
<b>Wet Tropics</b>	2018	2009	2019	2011	2003	2020	2015	2005
<b>Burdekin</b>	2019	2008	2009	2011	2015	2016	2004	2003
<b>Mackay-Whitsunday</b>	2012	2008	2010	2011	2004	2015	2003	2006
<b>Fitzroy</b>	2008	2010	2013	2011	2006	2005	2007	2004
<b>Burnett-Mary</b>	2012	2022	2013	2011	2021	2006	2007	2005

The wet-year maps for each NRM region are combined into a single, composite, Reef-wide map using the maximum value of the input rasters. This method captures wet-year plume conditions across the entire Reef even if the most significant plume events originate outside the NRM (e.g. if Fitzroy plumes are dominant in the Mackay-Whitsunday region the top-quartile discharges from the Fitzroy are already included in the composite raster). Conversely, the dry-year maps are combined into a Reef-wide composite map using the minimum value of the input rasters, which thus represents the least extensive plume from an average of the driest years in each NRM region.

Except for the coral recovery period, reference maps (long-term, Wet and Dry frequency maps) were all updated in 2023 (covering the 2004–2023 period) to ensure they remain valid as a representative period and to improve their accuracy as more satellite data becomes available. The previous update was in 2019. The daily, weekly, and wet season frequency maps are used to illustrate the wet season conditions for every year and to assess the extent of river flood plumes and resuspension events Reef-wide and in the focus regions. They are used to compare seasonal with long-term trends, as well as trend in water composition during typical dry and wet years.

### 3.2.5 Surface loading maps

Surface loading maps representing the dispersion of river-derived pollutants (DIN, TSS, and PN) into the Reef have been developed as part of the MMP since 2003. The maps were initially produced using the method described in Gruber *et al.*, (2018). In 2018–19 a revised approach was developed using the eReefs marine models (Margvelashvili *et al.* 2018; Skerratt *et al.* 2019; Steven *et al.* 2019).

River plumes were modelled using a conservative tracer in the 1 km resolution eReefs marine model (GBR1). The daily files, containing individual river plumes, were downloaded from [https://dapds00.nci.org.au/thredds/catalog/fx3/gbr1\\_2.0\\_rivers/catalog.html](https://dapds00.nci.org.au/thredds/catalog/fx3/gbr1_2.0_rivers/catalog.html) and used to estimate the cumulative sum of each river tracer concentration over a water year (1 October to 30 September the following year). The cumulative exposure index integrates the tracer concentration above a defined threshold. It is a cumulative measurement of the exposure concentration and duration of exposure to dissolved inputs from individual river sources. It is expressed as Concentration × Days (Conc.Days). For example, if a grid cell was exposed to concentrations of 5% river water for 2 days, this gives an exposure index of 0.1 (0.05 × 2). If a grid cell was exposed to concentrations of 50% river water for 10 days, this gives an exposure index of 5 (0.5 × 10). Whenever river water concentration is greater than 1%, the exposure index is calculated and added to all other exposures in that wet season (i.e., it is cumulative). This index provides a consistent approach to assessing relative differences in exposure of Reef shelf waters to inputs from various rivers.

The mathematical formulation that expresses this concept is given below:

$$\text{Conc.Days} = \sum_{t=0}^T \text{Conc}_{\text{exceedance}} * t$$

where,

$$\text{Conc}_{\text{exceedance}} = \begin{cases} \text{Conc}(t) - \text{Conc}_{\text{threshold}}, & \text{where } \text{Conc}(t) > \text{Conc}_{\text{threshold}} \\ 0, & \text{where } \text{Conc}(t) \leq \text{Conc}_{\text{threshold}} \end{cases}$$

and  $\text{Conc}_{\text{threshold}}$  is defined here as 1% of the river concentration,  $\text{Conc}(t)$  represents the time-varying tracer concentration, and  $t$  is time in days from the beginning of the wet season ( $t_0 = 1$  October) and  $T_{\text{end of wet season}} = 1$  May. Cumulative exposure is calculated for each grid point in the model domain.

In this step, the end-of-catchment load for fine sediment, DIN, or PN was dispersed for each river assuming a direct relationship between pollutant and tracer concentration (conservative mixing). Thus, the surface load of fine sediment, DIN, or PN per km<sup>2</sup> was calculated as:

$$Surf. load = \frac{tracer}{pixel} \times \frac{[total load]}{[sum of tracer]} \times \frac{pixel}{km^2}$$

The total Reef surface load was calculated by summing the surface load outputs for the 17 rivers for which tracer data were available: Normanby, Daintree, Barron, Russell-Mulgrave, Johnstone, Tully, Herbert, Haughton, Burdekin, Don, O’Connell, Pioneer, Fitzroy, Calliope, Boyne, Burnett, and Mary.

The difference between the estimated wet season fine sediment, DIN, and PN loadings (tonnes km<sup>-2</sup>) in the Reef for the current water year was calculated and compared to the pre-development loads derived from the Source Catchments model (which have a degree of uncertainty; refer to McCloskey *et al.*, 2021). This can be interpreted as ‘anthropogenic’ fine sediment, DIN, or PN loadings, highlighting the areas of greatest change with current land use characteristics.

### 3.2.6 Mean long-term water quality concentrations across water types and colour classes

The classification of four Reef water types allows mapping of large Reef waterbodies with different colour characteristics and concentrations of optically active components (TSS, CDOM, and Chl-*a*), water quality indicators (e.g. nutrients levels; Devlin *et al.*, 2015; Petus *et al.*, 2019), and light attenuation levels (Petus *et al.*, 2018) typically found in the Reef during the wet season. Match-up of *in situ* concentrations of water quality parameters and the four Reef water types are performed to validate this concept and quantify the range and average of water quality concentrations found in each Reef water type. Several water quality components are investigated through match-ups between *in situ* data and the six colour class maps, including DIN, PO<sub>4</sub>, PP, PN, TSS, Chl-*a*, CDOM, and Secchi depth.

All mean concentrations of water quality parameters were reviewed for this report to ensure that the water type characterisation remains appropriate, and to improve its accuracy building on the field data that are collected every wet season. The colour class category and water type corresponding to the location and week of acquisition of each water quality sample were extracted from the archive of MODIS-Aqua (wet seasons 2003–2020) and Sentinel-3 (wet seasons 2020–2023) weekly colour class maps at the site location using the PointGeometry and/or Extract Values to Points tools in ArcGIS 10.7 (ESRI, 2019). Weekly composites were used rather than daily colour class/water type data to minimise data loss due to the periodic dense cloud cover in the Reef. This approach maximises the incorporation of water quality parameters measured during each wet season since 2003–04 that can be associated with a Reef water type (and colour class) category.

Ideally, match-ups between satellite and in situ water quality information should be performed using field data collected  $\pm 2$  hours from the satellite overpass. This is very complicated to achieve in the MMP, which is in part focused on responsive monitoring of flood events and in areas of the Reef where the cloud cover has a major influence during the wet season. The methodology above was thus selected to maximise the number of data points used to assess the water quality characteristics of each Reef water type. The limitations are considered acceptable as the mean concentrations of water quality parameters are used as a relative measure to assign a potential risk grading for each Reef water type (see below). However, the long-term average concentration values should not be used as an exact value *per se*.

The long-term concentrations of water quality parameters were calculated using all surface data (<0.2 m) collected between December and April by JCU since the 2003–04 water year, and up to April 2022. It included data collected by AIMS and the CYWP since the 2016–17 water year and covered all regions and waterbodies of the Reef, and all Reef water types. TSS and Chl-*a* data collected in mid-shelf and offshore areas as part of a Reef Trust Partnership project with the locations via the Crown of Thorns Starfish Control Program between December 2021 and April 2023 (Waterhouse et al., 2023) were also included. In previous assessments, long-term mean DIN, PP, and PN concentrations were calculated as: DIN = nitrite + nitrate + ammonia, PP = total phosphorus – total dissolved phosphorus, and PN = total nitrogen – DIN, respectively. In the current assessment, mean long-term direct measurements of PP and PN were used (rather than indirectly estimated values as above), and NO<sub>x</sub> was used instead of DIN and calculated as NO<sub>x</sub> = nitrite + nitrate due to its greater robustness than ammonia as an indicator of N availability in marine waters.

Boxplots of water quality concentration and Secchi depth are plotted against their water types and colour classes and the mean long-term water quality concentrations across the three wet season water types in all focus regions are presented (Figure 3-3). Detailed summaries of water quality parameters (mean, standard deviation, minimum, maximum, and number of values for each pollutant across colour classes and water types) for the long-term and reporting year are also available in each MMP report. The mean long-term TSS, Chl-*a*, PP, and PN concentrations are then assessed against wet season GVs as a relative measure to assign potential risk grading for each Reef water type. Reef-wide wet season GVs were derived from De'ath and Fabricius (2008).

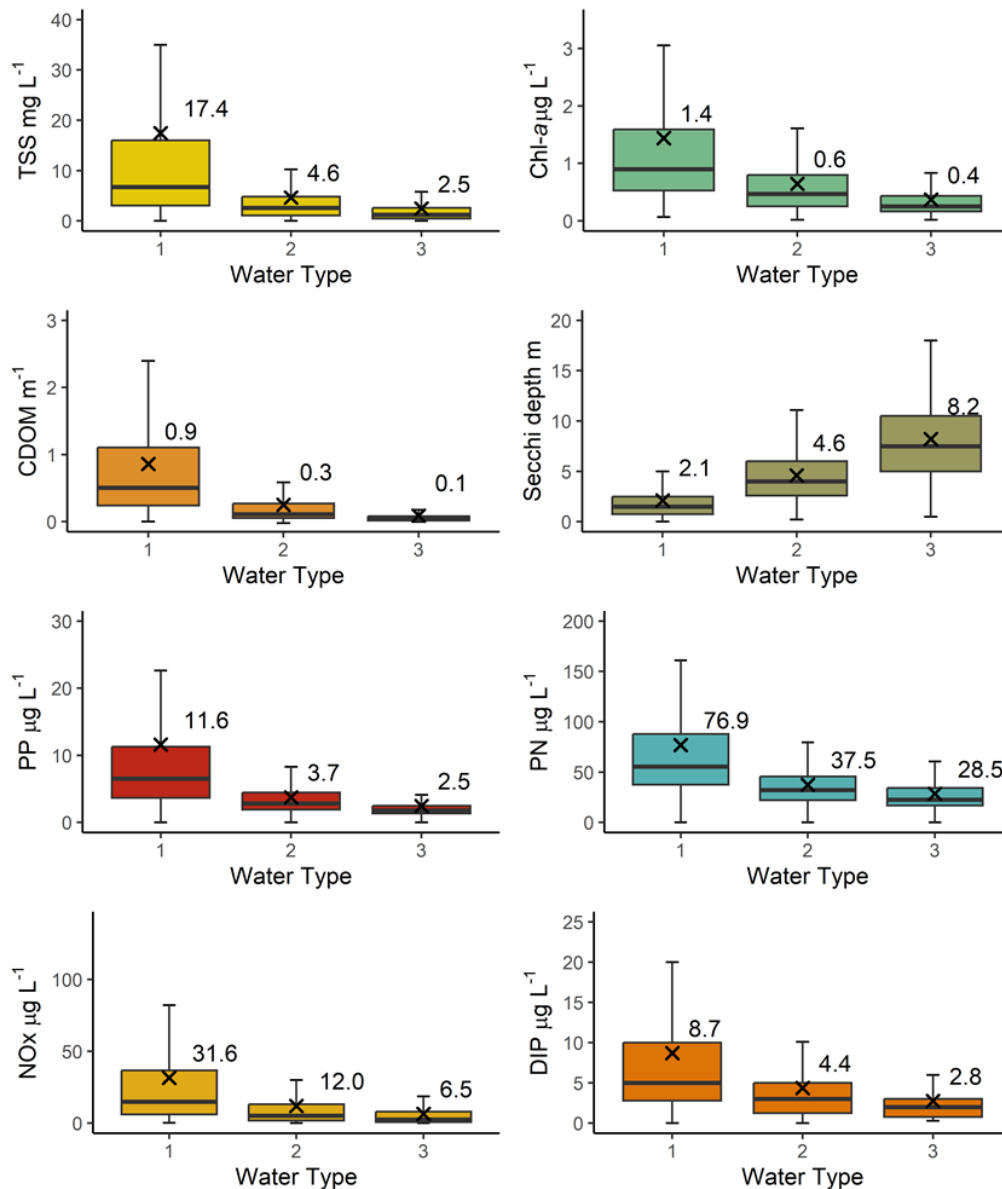

Figure 3-3 Long-term (2004–2023) concentrations of water quality parameters and Secchi depth boxplots for each Reef water type. Water types were extracted from the MODIS-Aqua (2004–2020) and Sentinel-3 (2021–2023) weekly satellite databases. The mean is plotted as a cross (x) and its numerical value is indicated in text. The interquartile range is delimited by the box and the median by the line inside the box. Whiskers indicate variability outside the upper and lower quartiles. Data beyond the whiskers range are considered outliers and are not plotted. Long-term WQ values have been reviewed for this report (last update was in 2019).

### 3.2.7 Exposure maps and exposure assessment

Information on the long-term water chemistry concentrations measured in the wet season colour classes (Figure 3-3) are compared to published water quality guideline values (Table 3-4) and, combined with frequency maps of occurrence of wet season water types, are used

in a “*magnitude x likelihood*” risk management framework to develop surface exposure maps (also referred to as potential risk maps in some Reef studies). Exposure maps are produced for the whole of the Reef, for all focus regions, and over the same timeframes as those reported for the frequency maps above. Long-term exposure composites were also reviewed for this report to produce 20-year composite maps.

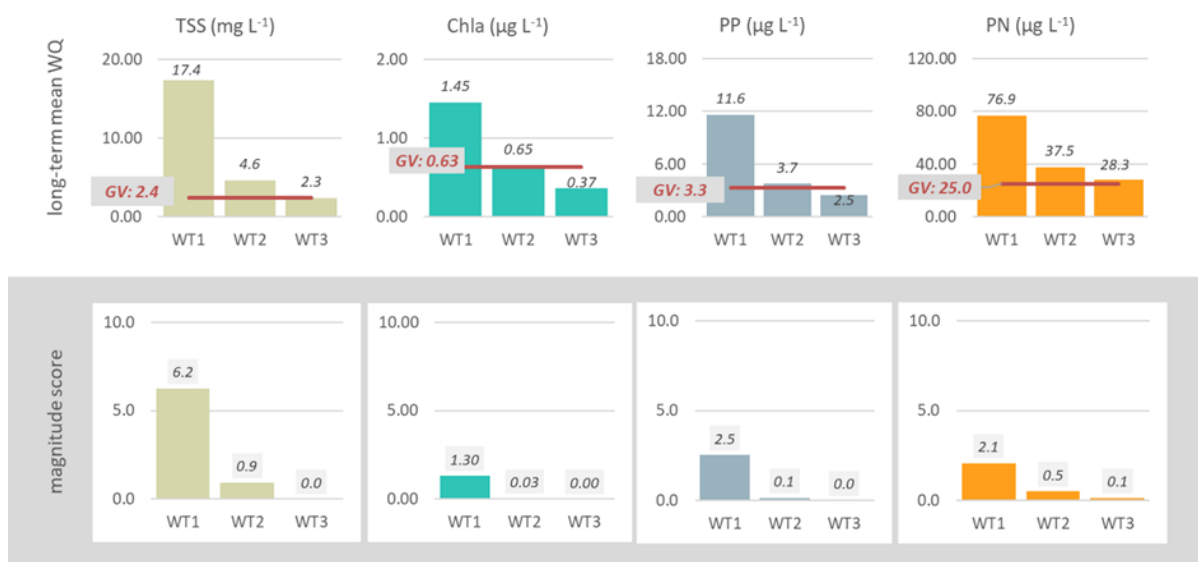

Figure 3-4 (top) Mean long-term water quality concentrations and (bottom) magnitude score across the three wet season water types. Red lines show the Reef-wide wet season GV. Magnitude scores are calculated as the proportional exceedance of the guideline:  $magnitude_{water\ type} = ([Poll.]_{water\ type} - GV)/GV$  and Poll. = TSS, Chl-a, PP, or PN. Negative Magnitude scores are scored as zero. Mean long-term water quality concentrations and Magnitude score have been reviewed for this report (last update was in 2019). Mean long-term water quality concentrations include samples collected from the enclosed coastal water type where high concentrations are likely to contribute to exceedances of the Reef-wide GV, particularly for Reef WT1 waters.

Different frameworks have been used to estimate the exposure and potential risk from exposure, (Petus *et al.* 2014b; Petus, C. *et al.* 2016), and used in the MMP reports before 2015–16. In a collaborative effort between the MMP monitoring providers (JCU water quality and seagrass teams and the AIMS coral monitoring team), an updated exposure assessment framework was developed in 2015–16 (modified from (Petus *et al.* 2016), where:

- The ‘magnitude of the exposure’ corresponds to the long-term concentration of pollutants (proportional exceedance of the guideline, Table 3-4) mapped through the Reef WT1, WT2, and WT3 (Primary, Secondary, and Tertiary water types).
- The ‘likelihood of the exposure’ is estimated by calculating the frequency of occurrence of each Reef water type.

The exposure for each of the water quality parameters defined is as the proportional exceedance of the guideline multiplied by the likelihood of exposure in each of the Reef water type and calculated as below.

Table 3-4 Reef-wide wet season guideline values used to calculate the exposure score for satellite exposure maps. These guidelines are based on seasonal adjustments to Reef-wide annual guidelines (Great Barrier Reef Marine Park Authority, 2010), where wet season guidelines are +20% for TSS, PN, and PP, and +40% for Chl-a of annual guidelines (De'ath and Fabricius 2008).

Parameter	Unit	Reef-wide
Chlorophyll <i>a</i>	µg L <sup>-1</sup>	0.63
Particulate nitrogen	µg L <sup>-1</sup>	25
Particulate phosphorus	µg L <sup>-1</sup>	3.3
Suspended solids	mg L <sup>-1</sup>	2.4

These GVs are compared against the mean long-term concentrations to calculate the exposure score in the satellite exposure maps (proportional exceedance of the guideline). Mean long-term water quality concentrations are calculated using all available surface water quality data in all Reef marine regions and water bodies (Table 3-5). The variability in the number of samples between regions and water types is primarily driven by the sampling design which was reviewed in 2014. The small number of samples in the Burnett-Mary region reflects the geographic extent of the MMP, with a majority of the samples collected by JCU in the 2011 and 2013 flood events when the design of the event monitoring was more opportunistic across the whole Reef. The relatively small number of samples in offshore waters reflects the geographic focus of the MMP design which is largely constrained to the open coastal and mid-shelf waters. Note also that the long-term and Reef-wide concentrations of water quality parameters are used rather than the seasonal and/or regional mean concentrations in water type to avoid bias due to differential regional and seasonal sampling distribution.

For each cell (500 m x 500 m) of the Reef and water type:

$$magnitude_{water\ type} = ([Poll.]_{water\ type} - GV)/GV$$

$$likelihood_{water\ type} = frequency_{water\ type}$$

$$Poll\_expo_{water\ type} = magnitude_{water\ type} \times likelihood_{water\ type}$$

where *water type* is the Reef WT1, WT2, or WT3 (primary, secondary, or tertiary wet season water types),  $[Poll.]_{water\ type}$  is the mean long-term TSS, Chl-a, PN, or PP concentration measured in each respective wet season water types and GV is the Reef-wide wet season guideline value from De'ath and Fabricius (2008) for TSS, Chl-a, PP, and PN (Table 3-4).

For each pollutant, the total exposure (*Poll\_expo*) is calculated at the exposure for each of the wet season water types:

$$Poll\_expo = Poll\_expo_{WT1} + Poll\_expo_{WT2} + Poll\_expo_{WT3}$$

The overall exposure score (*Score\_expo*) is calculated as the sum of the total exposure for each of the water quality parameters:

$$Score\_expo = TSS.exp + Chla.exp + PP.exp + PN.exp$$

Table 3-5 Number of collected *in situ* samples used in exposure scoring by region and water type. Samples include all wet season (Dec–April) surface samples since 2004 (from JCU) and since the 2016–17 water year (AIMS and the CYWP) and up to April 2022.

Region	Reef Water type	Secchi	TSS	Chl-a	CDOM	NO <sub>x</sub>	DIP	PP	PN
Cape York	WT1	157	208	218	160	214	218	102	80
	WT2	225	295	301	180	301	301	188	170
	WT3	126	176	181	109	178	178	120	111
	Marine	8	13	13	4	13	13	5	4
Wet Tropics	WT1	185	406	399	388	356	356	57	58
	WT2	400	623	637	574	611	615	228	229
	WT3	203	289	296	239	273	274	143	143
	Marine	25	33	35	29	33	33	19	19
Burdekin	WT1	102	157	156	113	151	155	63	73
	WT2	202	258	260	194	258	260	99	106
	WT3	61	97	96	71	81	82	40	40
	Marine	21	33	39	23	28	29	20	19
Mackay-Whitsunday	WT1	28	45	42	43	45	45	20	20
	WT2	73	134	129	98	127	132	74	75
	WT3	20	39	39	27	33	34	27	27
	Marine	7	13	13	8	9	10	6	6
Fitzroy	WT1	22	103	104	78	105	105	17	17
	WT2	27	64	78	65	82	84	22	22
	WT3	8	20	25	11	16	17	8	8
	Marine	0	6	6	1	6	6	0	0
Burnett-Mary	WT1	7	16	16	7	7	16	0	0
	WT2	5	9	9	5	5	9	0	0
	WT3	0	2	2	0	0	0	0	0
	Marine	0	8	8	1	3	3	0	0
Reef-wide	WT1	501	935	935	789	878	895	259	248
	WT2	932	1383	1414	1116	1384	1401	611	602
	WT3	418	623	639	457	581	585	338	329
	Marine	61	106	114	66	92	94	50	48

The overall exposure scores are then grouped into four potential classes (I to IV) based on a “Natural Break (or Jenks)” classification. Jenks is a statistical procedure, embedded in ArcGIS that analyses the distribution of values in the data and finds the most evident breaks in it (i.e., the steep or marked breaks; (Jenks and Caspall 1971). The Jenks classification

determine the best arrangement of values into different classes by reducing the variance within classes and maximizing the variance between classes.

The exposure classes are defined by applying the Jenks classification to the mean long-term exposure map (2003–2022), because this map presented the highest number of observations. Using the 2003–2022 mean exposure map, categories were defined as [ $>0-0.9$ ] = cat. I, [ $0.9-3.5$ ] = cat. II, [ $3.2-7.9$ ] = cat III and  $>7.9$  = cat IV. Category I and areas mapped as “exposure = 0 (no exposure)”, are re-grouped into a unique category I (no or very low exposure). These categories are applied to all exposure composites created (seasonal, coral recovery period, typical wet and dry periods – Reef-wide and for all focus regions).

The methods presented above are slightly different than methods used previous wet season’s reports (2016–17 and 2017–18 wet seasons) where (i) seasonal mean water quality concentrations across water types were used to produce the seasonal exposure map, (ii) exposure maps were reclassified using four equally-distributed colour classes and (iii) category I and areas mapped as “exposure = 0 (no exposure)” were not re-grouped into a unique category. Changes in 2019 (using only long-term mean WQ concentrations, a Jenk’s classification of the exposure maps, and regrouping cat I and 0) were made in response to: (i) concerns that water quality concentrations collected in a specific wet season would likely get biased toward the sample size and the location and timing of sampling in this particular wet season conditions and (ii) concerns that the equally-distributed categories were not responsive enough to changes in environmental pressures of each year, and (iii) to recognise that cat I is likely to have a low risk of any detrimental ecological effect.

Exposure maps are produced for the whole of the Reef, for all focus regions and over different time frames: for the current reporting wet season (using the Sentinel-3 FU imagery), over the long-term (2002–03 to 2021–22: 20 wet seasons), over a documented recovery period for coral reefs (2012–2017 period) and representation of typical wet-year and dry-year conditions. Except for the coral recovery period, reference maps (long-term, Wet and Dry frequency maps) were all updated in 2023 to ensure they remain valid as a representative period and to improve their accuracy as more satellite data are available. The previous update was in 2019. The ‘potential risk’ is influenced by the available MODIS data on cloud-free days, with the likelihood of risk assessment exposure likely underestimated in higher rainfall and cloudy regions like the Wet Tropics and Cape York.

Finally, assessments of ecosystem exposure are made through the calculation of the areas ( $\text{km}^2$ ) and percentages (%) of each Reef region, Reef waterbodies, coral reefs and seagrass meadows affected by different categories of exposure. The area and percentage are calculated as a relative measure between regions and waterbodies. The difference in percentages between the current year and in the long-term is also calculated. Processed data are stored in external Medias and in Dropbox.

Figure 3-5 presents the marine boundaries used for the Marine Park, each NRM region, the Reef waterbodies and the seagrass and coral reefs ecosystems. We assumed in this study that the shapefile can be used as a representation of the actual seagrass distribution. It is

known, however, that absence on the composite map does not definitively equate to absence of seagrass and may also indicate un-surveyed areas.

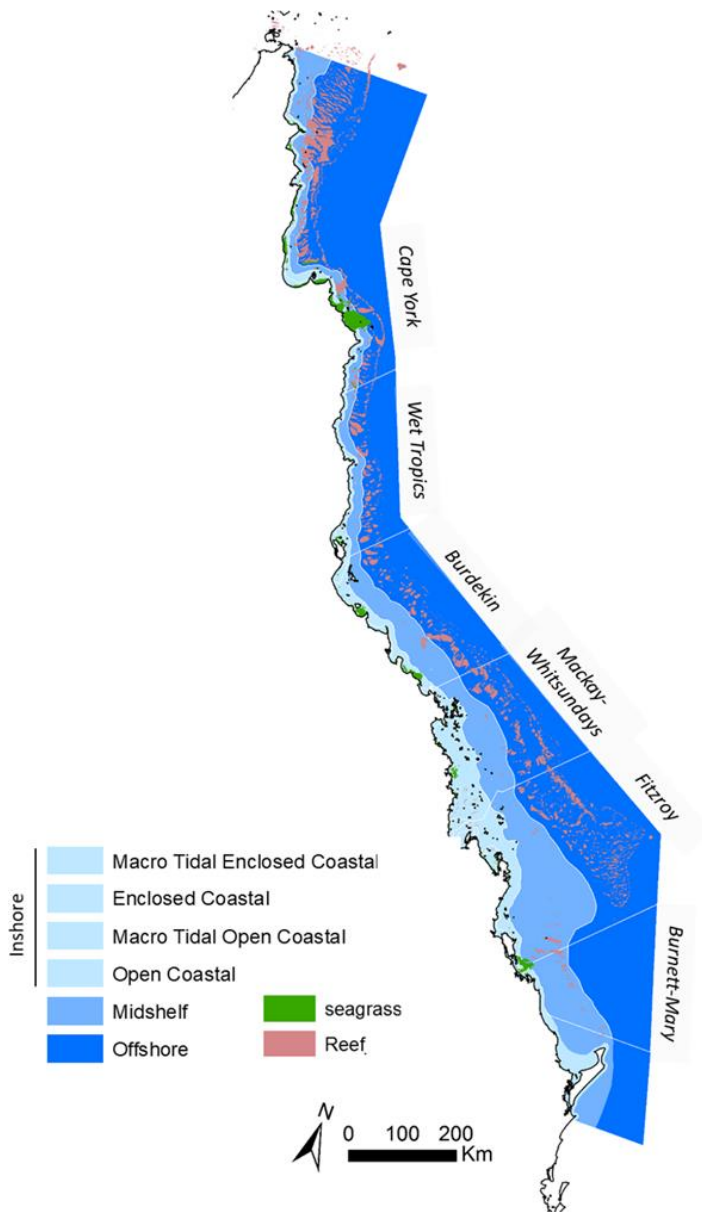

Figure 3-5 Boundaries used for the Marine Park, each NRM region, and the coral reefs and seagrass ecosystems. Coral reef and NRM layers derived from the Reef Authority, supplied 2013. Seagrass layer is a composite of surveys conducted by Department of Agriculture and Fisheries, QLD.

## 4 Pesticide monitoring

Kristie Thompson, Chris Paxman, Gabriele Elisei, Jochen Mueller, Sarit Kaserzon

Queensland Alliance for Environmental Health Sciences (QAEHS)

### 4.1 Introduction

The inshore waters of the Reef are impacted by the water quality of discharges from a vast catchment area, which can include inputs of pesticides (i.e. insecticides, herbicides and fungicides). The need for a long-term monitoring program on the Reef, which provides time-integrated data to assess temporal changes in environmentally relevant pollutant concentrations, was identified as a priority to address the information deficiencies about risks to the ecological integrity of this World Heritage Area in 2000 (Haynes and Michalek-Wagner 2000). The aim of this component of the MMP is to assess spatial and temporal trends in the concentrations of specific organic chemicals using time-integrated passive sampling techniques primarily through routine monitoring at specific sites.

Passive samplers accumulate organic chemicals such as pesticides from water in an initially time-integrated manner until equilibrium is established between the concentration in the water ( $C_W$  ng.L<sup>-1</sup>) and the concentration in the sampler ( $C_S$  ng.sampler<sup>-1</sup>). The concentration of the chemical in the water can be estimated from the amount of organic chemical accumulated within a given deployment period using calibration data obtained under controlled laboratory conditions. (Booij *et al.* 2007)

Passive sampling techniques offer time-integrated monitoring of both temporal and spatial variation in exposure in the often remote locations encountered on the Reef (Shaw and Mueller 2005). These techniques are particularly suited to large scale studies with frequently recurring pollution events (Schäfer *et al.* 2008) to ensure these events are captured and to allow the assessment of temporal trends in concentrations in systems over the long term (Muller *et al.* 2011; Kennedy *et al.* 2010).

Different types of organic chemicals must be targeted using different passive sampling phases. The passive sampling system utilized in the 2020-21 reporting period include:

- **Styrene divinyl benzene reverse phase sulfonate (SDB-RPS Empore™ Disk (ED)):** passive samplers for relatively hydrophilic organic chemicals with relatively low octanol-water partition coefficients ( $K_{ow}$ ) such as the photosystem II (PSII) herbicides (for example atrazine — a triazine herbicide); also referred to as polar organic chemical samplers.

Polydimethylsiloxane (PDMS) passive samples are used to detect more hydrophobic pesticides such as propiconazole, pendimethalin, chlorpyrifos and trifluralin) were not deployed in the 2022–23 wet season.

## 4.2 Methods

### 4.2.1 Sampling design — Passive sampling for routine monitoring

Before the 2014–15 monitoring year, 12 sites were routinely monitored across the four NRM regions (Wet Tropics, Burdekin, Mackay Whitsunday and Fitzroy) (see previous QA/QC and annual reports). Following a review of the program in 2019, there was a consensus to discontinue monitoring at several locations due to poor statistical power in detecting trends in pesticide concentrations, and initiate sampling in new locations that would better link end-of-catchment loads with inshore concentrations of pesticides. In 2020–21, a total of 3 high risk sites in the Mackay-Whitsundays (Repulse Bay, Flat Top Island and Sandy Creek) were selected for the monitoring. Samplers were deployed monthly during the wet season.

For the 2022–23 wet season, ten locations were routinely monitored. Passive samplers were deployed monthly during the wet season. Grab samples were taken during each passive sampler deployment/retrieval, as a complementary sampling technique. Additional grab samples were also taken during flood events to capture pesticide loads being transported to inshore Reef locations via floodwaters.

In addition to the scientific requirements of the project, the selection of passive sampling deployment sites is governed by practicalities, which include safety, security, availability of sites and site access. Site establishment is ultimately determined by the Reef Authority.

### 4.2.2 Target pesticides in the different passive samplers

The chemicals targeted for analysis in the different passive samplers and the limits of quantitation (LOQ) for ED and grab samples are indicated in Table 4-1. This list of target chemicals was derived through consultation with the Reef Authority with the criteria being:

- detected in recent studies
- recognised as a potential risk (through known usage patterns, amounts and existing toxicity data)
- analytical affordability
- within the current analytical capabilities of QAEHS
- likelihood of accumulation in one of the passive samplers (exist as neutral species in the environment)
- are included in complementary Reef 2050 Water Quality Improvement Plan programs such as end-of-catchment loads monitoring.

Table 4-1 List of Targeted Pesticides with corresponding LOQ for both ED and grab water samples.

Chemical	Description	Priority or of interest	LC-MS/MS	
			ED LOQ ng sampler <sup>-1</sup>	ED LOQ ng sampler <sup>-1</sup>
2, 4-D	Phenoxy-carboxylic-acid herbicide	Priority	5.0	0.84
Ametryn	PSII herbicide – methylthiothiazine	Priority	5.0	0.36
Atrazine	PSII herbicide – chlorotriazine	Priority	1.0	0.76
Atrazine – desethyl	PSII herbicide breakdown product (also active)	Priority	1.0	1.0
Atrazine – desisopropyl	PSII herbicide breakdown product (also active)	Priority	1.0	1.1
Bromacil	PSII herbicide – uracil	Of interest	1.0	1.2
Diuron	PSII herbicide – phenylurea	Priority	0.5	0.74
Fluazifop	Herbicide: inhibition of acetyl CoA carboxylase	Of interest	0.1	0.9
Fluometuron	PSII herbicide – urea	Of interest	1.0	0.6
Fluroxypyr	Pyridine carboxylic acid herbicide	Priority	1.0	2.0
Haloxyfop	Aryloxyphenoxy-propionate herbicide	Priority	1.0	1.0
Hexazinone	PSII herbicide – triazinone	Priority	1.0	0.96
Imazapic	Imidazolinone herbicide	Priority	1.0	10
Imidacloprid	Neonicotinoid insecticide	Priority	1.0	1.1
MCPA	Phenoxy-carboxylic-acid herbicide	Priority	5.0	1.1
Metolachlor	Chloracetanilide herbicide	Priority	1.0	0.92

Chemical	Description	Priority or of interest	LC-MS/MS	
			ED LOQ ng sampler <sup>-1</sup>	ED LOQ ng sampler <sub>1</sub>
Metribuzin	PSII herbicide – triazinone	Priority	1.0	1.2
Metsulfuron methyl	Sulfonylurea herbicide	Priority	1.0	1.7
Prometryn	PSII herbicide – methylthiothiazine	Priority	1.0	1.2
Propazine	PSII herbicide – chlorotriazine		1.0	1.1
Simazine	PSII herbicide – chlorotriazine	Priority	1.0	1.1
Tebuconazole	Conazole fungicide	Priority	1.0	0.64
Tebuthiuron	PSII herbicide – thiazolurea	Priority	1.0	0.22
Terbutylazine	PSII herbicide – triazine	Priority	1.0	1.0
Terbutryn	PSII herbicide – triazine	Of interest	5	0.92

Shaded chemicals are included as part of the Paddock to Reef Integrated Monitoring, Modelling and Reporting Program

Red text indicates that the sampling rate (Rs) of atrazine has been assumed

Pesticides are identified as 'priority' (proposed by Pesticide Working Group 18 August 2015) or 'of interest' to the program (feedback from the Paddock to Reef program) and include pesticides that are not currently analysed by QAEHS and are therefore not included in the MMP.

Table 4-1 lists the proposed priority pesticides that have been reported since 2014. Analytes for which analytical method development is required are noted. Note that this list includes priority pesticides and herbicides that may not accumulate well in passive samplers due to their polarity and may be detectable in grab samples only.

#### 4.2.3 Chemical analysis

From the 2014–2015 monitoring year onwards, the analysis of ED extracts at QAEHS was transferred to the AB Sciex QTRAP 6500 (a new LC-MS/MS model of the QTRAP 5500). The added advantage of this instrument is the enhanced sensitivity of some analytes and the ability to analyse in both positive and negative modes in one injection (effectively halving the analysis time required). LOQs of the target analytes were not negatively influenced by the change in instrumentation.

The limits of detection (LOD) and limits of quantitation (LOQ) for the LC-MS/MS instrument data have been defined as follows: a very low level amount of analyte is added to a range of matrices (which include saline (sea) water, Milli-Q water and bore water) and injected 7 times into the analytical instrument. The standard deviation of the resultant signals is obtained and a multiplication factor of three is applied to determine the LOD and a factor of ten is applied to get the limit of quantitation (LOQ). The LOQ is equivalent to the limit of reporting (LOR), unless analytes are detected in blank samplers, which raises the LOR. Grab LOQs presented in Table 4-1 are based on a sample volume of 500 mL. ED LOQs are shown as ng/sampler. The reporting limits for water concentrations determined using the passive samplers will vary according to the site's sampling rates (i.e. sampler deployment duration and flow rate at the site).

Positive results at QAEHS are confirmed by retention time and by comparing transition intensity ratios between the sample and an appropriate concentration standard from the same run. Samples were reported as positive if the two transitions were present (with peaks having a signal to noise ratio greater than three), retention time was within 0.15 minutes of the standard and the relative intensity of the confirmation transition was within 20 per cent of the expected value. The value reported was that for the quantitation transition.

#### 4.2.4 Passive sampling techniques

##### SDB-RPS Empore disks

- 3M™ Empore™ Extraction Disks (SDB-RPS) – Phenomenex.
- Deployed in a custom-made Teflon “Chemcatcher” housing (Kingston *et al.* 2000) (Figure 4-1).

Routine time integrated monitoring:

- Deployed with a diffusion limiting 47 mm, 0.45  $\mu\text{m}$  polyether sulfone membrane for approximately one month. From January 2012 onwards, Phenomenex membranes of the same specifications have been used.

#### Preparation:

- Disks are washed in acetone and isopropanol.
- Disks are conditioned first with methanol, then Milli-Q water, using a vacuum manifold.
- Disks are loaded into acetone rinsed Teflon Chemcatcher housing.
- Disks are covered with membrane and solvent rinsed wire mesh.
- Chemcatcher housing is filled with Milli-Q water.
- Chemcatcher samplers are sealed packaged for transport and stored at  $\sim 4^{\circ}\text{C}$
- Chemcatcher samplers are transported via insulated bags filled with ice packs.

#### Extraction:

- Remove membrane and wipe surface of disk with Kimwipe to remove excess water.
- Spike disk with labelled internal standard.
- Extract disk using acetone and methanol in a solvent rinsed 15 mL centrifuge tube in an ultrasonic bath.
- Concentrate to 1 mL using evaporation under purified  $\text{N}_2$  then centrifuge to separate any particles in extract.
- Supernatant is transferred to a clean tube and water added.
- Sample is then extracted with solid phase extraction (SPE; Strata-X polymeric reversed phase cartridges, Phenomenex)
- Cartridges are dried and eluted with methanol and acetone.
- Extracts are concentrated to 0.1 mL, then 0.4 mL 20% methanol in Milli-Q water is added.
- Extracts are filtered (0.22  $\mu\text{m}$  PFTE) into HPLC vials.
- Analyse using LC-MS/MS
- Convert to concentration in water using compound specific *in situ* sampling rates.



Figure 4-1 An Empore Disk being loaded into the Teflon Chemcatcher housing (left) and an assembled housing ready for deployment (right)

### ***In situ* flow monitoring for Empore Disks sampling rate adjustment**

Compound specific sampling rates have been determined for a broad suite of herbicides and are applied to the estimation of concentrations in water. Sampling rates are influenced by *in situ* environmental conditions such as flow. A passive flow monitor (PFM), comprised of dental plaster cast into a plastic holder (Figure 4-2), was developed as a means of flow-adjusting sampling rates using an *in situ* calibration device (O'Brien *et al.* 2009). The elimination rate of dental plaster from the PFM during the deployment is proportional to flow velocity, and the influence of ionic strength (salinity) on this process has been quantified (O'Brien *et al.* 2011). The sampling rates of reference chemicals in the ED, such as atrazine, have subsequently been cross-calibrated to the loss of plaster from the PFM under varying flow conditions (Figure 4-3) (O'Brien *et al.* 2011).



Figure 4-2 Passive flow monitors pre-deployment (left) and post-deployment (right)

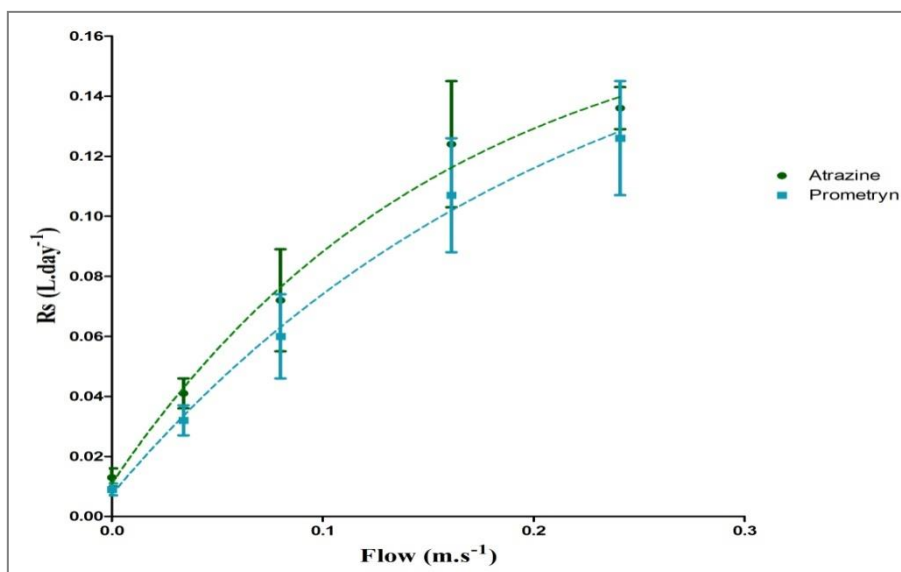

Figure 4-3 Relationship between flow and sampling rates of specific herbicides indicating a shift from aqueous boundary layer control to diffusion limiting membrane control under higher flow conditions

The *in-situ* calibration procedure of EDs employed at QAEHS is:

- PFMs are co-deployed alongside EDs.
- Deployment in:
  - Wet season (approx. one month, weather dependent).
- The loss rate of plaster is determined while accounting for the influence of ionic strength.
- The sampling rates of atrazine and prometryn are directly predicted from the PFM loss rate using models.

The sampling rates of other individual herbicides are predicted based on the average ratio of the  $R_s$  of atrazine to the individual herbicide  $R_s$  across multiple calibration studies (O'Brien *et al.* 2011; Vermeirssen *et al.* 2009; Stephens *et al.* 2009; Shaw and Mueller 2009). For newly included target herbicides where there is no calibration data available, QAEHS may adopt the sampling rate of atrazine (and report this consistently throughout the monitoring program to allow inter-site and inter-year comparisons) or present the data as ng accumulated per sampler per day. Chemicals for which the  $R_s$  of atrazine are assumed are highlighted red in Table 4.1. An in-field calibration would be beneficial in determining  $R_s$  for the newly included chemicals.

#### 4.2.5 Risk assessment metrics:

For the 2022-23 monitoring period, the pesticide risk metric (PRM) was calculated and applied to the estimated pesticide water concentrations (Warne *et al.*, 2023). The PRM uses 22 pesticides (nine PSII herbicides, ten ‘other’ herbicides and three insecticides) to calculate the combined risk to aquatic species, expressed as the average percentage of species affected. These pesticides (2,4-D, ametryn, atrazine, chlorpyrifos, diuron, fipronil, fluroxypyr, haloxyfop, hexazinone, imazapic, imidacloprid, isoxaflutole, MCPA, metribuzin, metolachlor, metsulfuron-methyl, pendimethalin, prometryn, simazine, tebuthiuron, terbuthylazine, triclopyr) were chosen due to their previous detection in GBR waterways, and because they had species sensitivity distributions (SSDs) available. SSDs were combined with the multisubstance-potentially affected fraction (msPAF) method, Independent Action model of joint toxicity and Multiple imputation method to calculate the PRM.

Despite being widely used and simple to calculate, a limitation of the PSII-HEq approach is that matched datasets should ideally be used to derive the potencies relative to a reference chemical (i.e. for each species tested, all PSII herbicides should be included in the same study to assess their toxicity relative to diuron). However, this seldom occurs and, typically, datasets will have data for only a few select compounds. This requirement for matched datasets dramatically reduces the amount of data suitable to derive relative potencies.

The multisubstance-potentially affected fraction msPAF method (Traas *et al.* 2002) has been proposed as a more relevant approach to quantify the overall ecological risk of mixtures of pollutants for ecological communities. This approach is based on species sensitivity distributions (SSDs) for all chemicals in a mixture, and thus aligns more closely with the revised methods for proposed individual water quality guideline value derivation, as well as the risk-based approach adopted by the Paddock to Reef Program. The PAF of species, i.e. percent of species in an ecosystem that will theoretically be affected at a given mixture environmental concentration, is considered an ecologically relevant assessment end point, which better suits the goals of the Reef 2050 Water Quality Improvement Plan.

The msPAF can account for both additive and non-additive interactions, i.e. it can determine a cumulative toxicity for a mixture of chemicals with the same toxic mode of action (for example, for PSII inhibition, effects are assumed additive for all PSII-inhibiting herbicides in a mixture), but also for a mixture of chemicals with different modes of action (non-additive model). Non-additive interactions are an important consideration given the apparent shift towards the use of alternative pesticides with different modes of action in the Reef catchments. At present, however, only the additive model is being implemented (for PSII inhibiting herbicides and SSDs for the full suite of priority chemicals are currently under development). The benefits and rationale of adopting this method include:

- More data can be used to generate more robust estimates of risk.
- The use of SSDs is consistent with the Australian and New Zealand Guidelines for Fresh and Marine Water Marine Quality (ANZECC & ARMCANZ 2000) and with the risk-based approach of the Paddock to Reef Program.

- The risk is quantified in easy-to-understand terms of modelled percentages of species that will be affected (i.e. protecting 95 per cent of species is better than protecting 75 per cent) and again is consistent with the Australian and New Zealand Guidelines for Fresh and Marine Water Marine Quality (ANZECC & ARMCANZ 2000).
- It allows for aggregating risks of compounds in a mixture.
- The toxic effect of mixtures on multiple species can be determined.
- It can be used as a measure of ecological risk, i.e. a certain fraction of species expected to be (potentially) affected above its no-effect level at a given environmental concentration and allows comparisons between substances, species groups, sites and regions.
- Any consistent set of toxicity endpoints can be used to generate SSDs, e.g. no observed effect concentration (NOEC) and half maximal effective concentration (EC<sub>50</sub>).

#### 4.2.6 QA/QC procedures in the pesticide monitoring program

The development, calibration, field application and validation of passive sampling for monitoring water has been a research focus of QAEHS over many years. The methods described above have been developed as a result of this work in collaboration with analytical method development. These methods are formalized as Standard Operating Procedures (SOPs), which describe the preparation, extraction, and analysis of each type of passive sampler used in the MMP. Considering the number of new target pesticides and herbicides included as priorities under the MMP, an in-field calibration study would be beneficial to determine chemical uptake kinetics.

QA/QC procedures routinely employed by QAEHS in the MMP include:

- Internally approved and reviewed SOPs for the preparation, deployment, extraction, and analysis of passive samplers.
- Staff training in relevant SOPs(laboratory) and maintaining staff training records.
- Deployment guides for the training of field staff and volunteers
- Generation of a unique alphanumeric identifier code for each passive sampler
- Preparation, extraction, storage (4°C or -20°C) and subsequent analysis of procedural blank passive samplers with each batch of exposed passive samplers
- Use of labelled internal standards or other surrogate standards to evaluate or correct for recovery or instrument sensitivity throughout the extraction and within the analysis process respectively.
- Exposure of replicate samplers during each deployment that are extracted and archived in QAEHS specimen bank at -80°C.
- Participation in interlaboratory studies, cross-checking a selection of samples with Queensland Health Forensic and Scientific Services (QHFSS) and routine

participation in the international passive sampling proficiency studies run via the Dutch QUASIMEME organisation.

### 4.3 Data management and security

The data management protocols for QAEHS are outlined below and include documentation of all steps within the sampling program: passive sampler identification, transport, deployment, chemical analysis, analytical results, data processing, storage and access. This protocol may be summarised as:

- The unique alphanumeric identifier code attached to each sample is applied to all subsequent daughter samples and results, ensuring a reliable link with the original sample.
- Deployment records are sent with the sampling devices, and include information on the unique sampling device identifier, deployment identifier, name of the staff/volunteer who performed the operation, storage location, destination site, important dates, details of sample treatment and any problems that may have occurred. When returned, the information is entered into Excel spreadsheets and stored on the QAEHS main server with a back-up on one local hard drive.
- Detailed chain of custody records is kept with the samplers at all times. Devices are couriered directly to the tourism operators/community member and monitored via a tracking system. Delivery records are maintained by QAEHS to guarantee traceability of samples.
- LC-MS/MS results files with a unique identifier code are transferred from the instrumentation computer to the UQ QAEHS server.
- Excel spreadsheets used for data processing and a summary results file (concentration in water estimates) are stored on the UQ QAEHS secured server. Access to the QAEHS server is restricted to authorised personnel only via a password protection system. Provision of data to a third party only occurs at the consent or request of the program manager.

### 4.4 Summary

In summary, the following QA/QC measures are employed:

- Unique sample identifiers
- Comprehensive records and chain of custody paperwork across all components
- Training of field personnel, including deployment guidelines and records
- Analytical quality control measures
- Procedural QA/QC for the preparation, extraction and analysis of passive samplers including SOPs
- Inclusion of QA/QC samples (replication of sampling and procedural blanks)
- Continual evaluation, method development and improvement of methods for sampler processing and estimation of concentration in water.

## 5 Inshore coral reef monitoring

Angus Thompson, Johnston Davidson, Cassandra Thompson

Australian Institute of Marine Science

### 5.1 Introduction

This component of the MMP aims to accurately quantify temporal and spatial variation in inshore coral reef community status in relation to variations in local reef water quality. Steep gradients in water quality across the inshore region of the Reef are reflected in differences in benthic community composition (Uthicke *et al.* 2010). Changes in these communities may be due to acute disturbances such as cyclonic winds, bleaching or crown-of-thorns starfish as well as more chronic pressures related to run-off (for example increased sediment and nutrient loads) that may disrupt processes of recovery from such disturbances or lead to long-term changes in communities due to altered selective pressures.

Salient attributes of a healthy ecological community are that it should be self-perpetuating and 'resilient', that is, able to recover from, or resist, disturbance. While the spatial sampling design of the program explicitly attempts include reefs across gradients in environmental conditions, the temporal design and variables measured focus on the resilience of these communities to both acute and chronic environmental pressures (Thompson *et al.* 2020).

To quantify inshore coral reef community status and resilience in relation to variations in local reef water quality, this section of the project has several key objectives:

- Identify the trends in the condition and composition of benthic communities for Great Barrier Reef inshore coral reefs against desired outcomes along identified or expected gradients in water quality.
- Assess the extent, frequency and intensity of acute and chronic impacts on the condition of inshore coral reefs associated with sediments and nutrients transported by run-off.
- Identify the trajectories of recovery for inshore coral reef communities following impacts resulting from exposure to flood plumes (and associated sediments and nutrients), cyclones and thermal bleaching events.
- Identify the key drivers of coral mortality and the trends in coral reef resilience indicators on inshore reefs.
- Provide information about sea temperature as a potential driver of environmental conditions at inshore reefs.
- Provide an integrated assessment of coral community condition for the inshore reefs monitored to serve as a report card against which changes in condition can be tracked.
- Maintain a local database of all sample data and associated metadata and data summaries.

## 5.2 Methods

### 5.2.1 Sampling design

The sampling design was selected for the detection of change in benthic communities on inshore reefs in response to improvements in water quality parameters relevant to specific catchments, or groups of catchments (Region), and to disturbance events. Within each Region, reefs are selected along a gradient of exposure to run-off, largely determined as increasing distance from a river mouth in a northerly direction. To account for spatial heterogeneity of benthic communities within reefs, two sites were selected at each reef (Figure 5-1).

Observations on a number of inshore reefs undertaken by AIMS in 2004 during the pilot study to the current monitoring program (Sweatman *et al.* 2007) highlighted marked differences in community structure and exposure to perturbations with depth; hence sampling within sites is stratified by depth. Within each site and depth, fine scale spatial variability is accounted for by the use of five replicate transects.

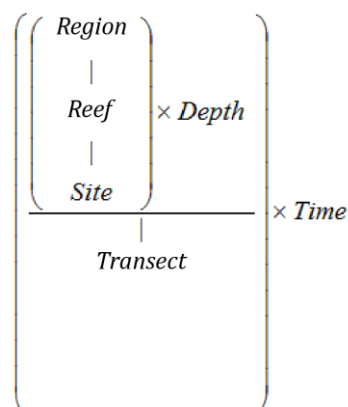

Figure 5-1 Sampling design for coral reef benthic community monitoring. Terms within brackets are nested within the term appearing above.

### 5.2.2 Site selection

The reefs monitored were selected by the Authority, using advice from expert working groups. The selection of reefs was based upon two primary considerations:

- To make sure that the sampling locations in each catchment of interest were spread along a perceived gradient of influence from river output.
- Evidence (in the form of carbonate-based substrate) that coral reef communities had been viable (net positive accretion of a carbonate substrate) in the past.

Where well-developed reefs existed on more than one aspect of an island, two reefs were included in the design because, although position relative to run-off exposure would be similar, often quite different communities exist on windward compared to leeward reefs.

Over time, there have been some adjustments made to the sampling design (Table 5-1). For the first two years of the project (2005 and 2006), 35 reefs were surveyed each year. In 2007 fringing reefs along the Cape Tribulation coast were removed from the program due to concerns over crocodile attack. In addition, the sampling frequency changed so that only a subset of “core” reefs were surveyed annually with the remaining “cycle” reefs surveyed every other year (Table 5-1). From 2015, the sampling changed again with King Reef replaced by Bedarra Island in the Tully Catchment, Middle Reef removed from the program as this was also a site monitored by the AIMS Long-term Monitoring Program, and all reefs scheduled for sampling biennially, half surveyed in ‘odd-years’ and half surveyed in ‘even-years’. Importantly, when an acute disturbance was suspected of having impacted survey reefs during the preceding summer, the biennial design allowed for contingency sampling of up to six reefs not scheduled for survey so as to improve estimates of impact and book-end the start of the recovery period. In 2020 all reefs were monitored to document the impact of high water temperatures in early 2020. In 2021 the program returned to an annual frequency of monitoring for all reefs and Peak Island was removed from the program on the basis of not having substantive development of a carbonate substrate. In addition to these adjustments, as of 2015 data from inshore reef sites surveyed under the Long-term Monitoring Program (LTMP) were included in the analysis and reporting of inshore coral reef condition (Table 5-1). A map of sites included since 2021 is presented in Figure 5-2.



Figure 5-2 Coral locations that exist as of 2021.

Table 5-1 Scheduled coral monitoring sampling design for the MMP. Site names in *italics* are monitored by the AIMS Long-term Monitoring Program and included in MMP reporting. Waypoints for each site and depth monitored can be found in Appendix B1.

NRM Region	Catchment	Monitoring location	2005-2006	2007-2014	2015 –2020	Since 2021
Wet Tropics	Barron Daintree	<i>Low Isles</i>	O	O	O	A
		Snapper North	A	A	O	A
		Snapper South	A	A	E	A
	Russell / Mulgrave Johnstone	<i>Green Island</i>	O	O	O	
		Fitzroy East	A	E	E	A
		Fitzroy West	A	A	O	A
		<i>Fitzroy West</i>	O	O	O	A
		Frankland East	A	O	O	A
		Frankland West	A	A	E	A
		High East	A	O	O	A
		High West	A	A	E	A
	Herbert Tully	Barnards	A	O	O	A
		Bedarra			A	A
		Dunk North	A	A	E	A
		Dunk South	A	E	E	A
		King	A	O		
Burdekin	Burdekin	Havannah Island	A	O	O	A
		<i>Havannah Island (North)</i>	O	O	O	A
		Lady Elliot	A	E	E	A
		Magnetic	A	A	O	A
		<i>Middle Reef</i>	O	O	O	
		Palms East	A	E	E	A
		Palms West	A	A	O	A
		Pandora	A	A	E	A
		<i>Pandora (North)</i>	O	O	O	A
Mackay Whitsunday	Proserpine	<i>Border</i>	O	O	O	A
		Daydream	A	A	E	A
		Dent	A	E	E	A
		Double Cone	A	A	E	A
		<i>Hayman</i>	O	O	O	A
		Hook	A	E	E	A
		<i>Langford</i>	O	O	O	

NRM Region	Catchment	Monitoring location	2005-2006	2007-2014	2015 –2020	Since 2021
		Pine	A	A	O	A
		Seaforth	A	O	O	A
		Shute	A	O	O	A
Fitzroy	Fitzroy	Barren	A	A	O	A
		Keppels South	A	A	E	A
		Middle	A	E	E	A
		North Keppel	A	O	O	A
		Peak	A	A	O	
		Pelican	A	E	E	A

**A**, Reefs designated as 'core reefs' and sampled annually, prior to 2015 or from 2021

**O**, Reefs scheduled for sampling in odd numbered years

**E**, Reefs scheduled for sampling in even numbered years

*Italics identify reefs surveyed by the AIMS long-term monitoring program*

Table 5-2 Distribution of sampling effort

Survey Method	Information provided	Transect coverage	Spatial coverage
Photo point intercept	Percentage cover of the substrate for major benthic habitat components	Approximately 25 cm belt along upslope side of transect from which 160 points are sampled	Full sampling design
Juvenile counts *	2005-2006 Size structure of coral communities, recorded into: 0-2cm, >2-5cm, >5-10cm, >10-20cm, >20-50cm, >50-100cm and >100cm categories	A 34 cm belt along the upslope side of each transect	First 10m of each transect
	2007-2018, density of juvenile corals in size classes: 0-2cm, >2-5cm, >5-10cm	A 34 cm belt along the upslope side of each transect	Full sampling design
	2019 on, density of juvenile hard corals in size classes: 0-2cm, >2-5cm	A 34 cm belt along the upslope side of each transect	Full sampling design
Scuba search	Incidence of factors causing coral mortality	Two-metre belt centred on transect	Full sampling design

### 5.2.3 Depth selection

From observations of a number of inshore reefs undertaken by AIMS in 2004, marked differences in community structure and exposure to perturbations with depth were noted

(Sweatman *et al.* 2007). The lower limit for the inshore coral surveys was selected at five metres below datum because coral communities rapidly diminish below this depth at many reefs; two metres below datum was selected as the shallow depth. Shallower depths were considered but discounted for logistical reasons, including the inability to use the photo technique in very shallow water, site markers creating a danger to navigation and difficulty in locating a depth contour on very shallow sloping substrata typical of reef flats. Sites surveyed under the LTMP are generally in the range of 5-7metres below datum and reported along with the 5m depths of the MMP.

#### **5.2.4 Field survey methods**

##### **Site marking**

Each selected reef site is permanently marked with steel fence posts at the beginning of each 20-metre transect and smaller (10 mm diameter) steel rods at the 10-metre mark and end of each transect. Compass bearings coupled with distance along transects record the transect path between these permanent markers. Transects were set initially by running two 60-metre fibreglass tape measures out along the desired five- or two-metre depth contours. Digital depth gauges were used along with tide heights from the closest location included in 'Seafarer Tides' electronic tide charts produced by the Australian Hydrographic Service. There are five-metre gaps between each consecutive 20-metre transect. The position of the first picket of each site is recorded with a Global Positioning System (GPS) and waypoints maintained in the AIMS database.

##### **Sampling methods**

Three separate sampling methodologies are used to describe the benthic communities of inshore coral reefs (Table 5-2). These are each conducted along the fixed transects identified in the sampling design Table 5-1.

##### **Photo point intercept method**

This method is used to gain estimates of the proportional cover of benthic community components. The method follows closely SOP Number 10 of the AIMS LTMP (Jonker *et al.*, 2008). In short, digital photographs are taken at 50-centimetre intervals along each 20-metre transect. Estimation of cover of benthic community components is derived from the identification of the benthos lying beneath points overlaid onto these images. For the majority of hard and soft corals, at least genus level identification is achieved. The categories used for identification of benthos are listed in (Jonker *et al.* 2008), although additional genus level codes for some algae have since been added.

The primary difference in the application of the method in this project from that described in (Jonker *et al.* 2008) is in the sampling design. Sampling for this project is based on 20-metre transects, rather than 50-metre transects. To compensate for transects being shorter than in the standard method, the density of frames per unit area of transect is doubled (images captured at 0.5 metre rather than at one-metre intervals). This alteration to the standard technique was adopted owing to the limited size of some of the reefs sampled. This

modification in methodology of course does not apply to the sites monitored under the LTMP, which use the 50-metre transects and one image per metre.

### **Juvenile coral surveys**

These surveys aim to provide an estimate of the number of hard and soft coral colonies that were successfully recruiting and surviving early post-settlement pressures. In the first year of sampling under this program, these juvenile coral colonies were counted as part of a demographic survey that counted the number of individuals falling into a broader range of size classes (Table 5.1). As the focus narrowed to just juvenile colonies, the number of size classes reduced allowing an increase in the spatial coverage of sampling.

From 2006 to 2017, coral colonies less than 10 centimetres in diameter were counted within a belt 34-centimetres wide (data slate length) along the upslope side of each 20-metre transect. Each colony was identified to genus and assigned to a size class of 0–2 cm, >2–5 cm or >5–10 cm. Importantly, this method aims to estimate the number of juvenile colonies that result from the settlement and subsequent survival and growth of coral larvae rather than small coral colonies resulting from fragmentation or partial mortality of larger colonies. With the exception of the transect dimension and the size classes used, this method is consistent with SOP Number 10 of the AIMS LTMP, Part 2, in which further detail relating to juvenile/fragment differentiation can be found (Jonker *et al.* 2008). Data on juvenile density provided by the LTMP for the relevant sites listed in Table 5-1 are collected according to (Jonker *et al.* 2008) with no modification.

Since 2018 only the 0-2 cm and >2-5 cm size classes were recorded as these are the only size classes that are reported in the Reef report card and provides a more consistent method to that used by the LTMP.

### **Scuba search transects**

Scuba search transects document the incidence of agents causing coral mortality or disease. Tracking of these mortality agents is important because declines due to these agents must be carefully considered as covariates for possible trends associated with response to outcomes. The method used follows closely SOP Number 9 of the AIMS LTMP, Part 2 (Miller *et al.* 2009). In short, a search is made of a two-metre wide belt (one metre either side of the transect midline) for any recent scars, bleaching, disease or damage to coral colonies. An extra category not included in the standard procedure is physical damage. This is recorded on the same five-point scale as coral bleaching and describes the proportion of the coral community that has been physically damaged, as indicated by toppled or broken colonies. This category may include anchor as well as storm damage. Scuba search data provided by the LTMP for the relevant sites listed in Table 5-1 is collected with strict adherence to SOP Number 9 of the AIMS LTMP, Part 2 (Miller *et al.* 2009).

### 5.2.5 Observer training

The AIMS personnel collecting data in association with this project are without exception highly experienced in the collection of benthic monitoring data. Each observer was employed specifically for their skills in benthic monitoring and benthic organism identification.

Ongoing standardisation of observers is achieved by photo-based comparisons that, for the most, mitigate inconsistencies in identification. As a final step in reducing bias in sampling, all photo-transect identifications are double checked by a single observer.

In the event that new observers enter the team, training in each sampling method is by direct tuition with an experienced observer. New observers must meet the standards listed in Table 5-3 before collecting data for the project.

Table 5-3 Observer training methods and quality measures

Monitoring method	Training method	Quality measure
Photo point intercept	In-field identification of benthic components. On screen classification of photo points. In-field tuition on photographic protocol.	All identifications double checked.
Juvenile counts	In-field identification of corals to genus level and application of technique with experienced observer supervision.	No greater than 10 per cent of colonies misidentified, overlooked or misclassified in size during supervised demographic surveys of two sites.
Scuba search	In-field tuition in the classification of coral scars and damage.	Observation of at least 90 per cent of damaged colonies and their correct classification during supervised surveys of two sites of damaged colonies.

Classification to genus level underwater is augmented by the use of a small digital camera to take images for post-dive scrutiny of difficult to identify colonies. However, some small juvenile corals are difficult to differentiate in the field and, while they are identified to genus level, they are typically merged with similar genera for analysis and reporting.

Sea Research is responsible for surveys in the Daintree catchment. The Sea Research observer, Tony Ayling, is the most experienced individual in Australia in surveying the benthic communities of near-shore coral reefs. He has 30+years' experience surveying the sites in this catchment, amongst many others. His taxonomic skills are undoubted at genus level and, as such, observer standardisation for demography and scuba search surveys are limited to detailed discussion of methodologies with AIMS observers and explicit following of

the protocols listed here. Sea Research also use the same pre-printed datasheets. Analysis of transect images collected by Sea Research is undertaken by AIMS.

### 5.2.6 Temperature monitoring

Temperature loggers are deployed at, or in close proximity to, all locations at both two-metre and five-metre depths and routinely exchanged either at the time of the coral surveys (i.e. prior to 2020 every 12-24 months and every 12 months since) or every four months at sites where FLNTU loggers are co-located (Table 2.1). Three types of temperature loggers have been used for the sea surface temperature logger program. The first type was the Odyssey temperature loggers (<http://www.odysseydatarecording.com/>), which were superseded by the Sensus Ultra Temperature logger (<http://reefnet.ca/products/sensus/>). In 2015, Vemco minilog temperature loggers (<http://vemco.com/products/minilog-ii-t/>) began to replace aging Sensus loggers.

The Odyssey loggers were set to take readings every 30 minutes. The Sensus and Vemco loggers were set to take readings every 10 minutes. Loggers were calibrated against a certified reference thermometer after each deployment and generally accurate to  $\pm 0.2^{\circ}\text{C}$ .

Detailed data download, quality checks and data management methods are described in Appendix A11.

## 5.3 Data management

Data management practices are a major contributor to the overall quality of the data collected; poor data management can lead to errors and lost data and can reduce the value of the MMP data. Data from the AIMS MMP inshore coral reef monitoring are stored in a custom-designed data management system in Oracle databases to allow cross-referencing and access to related data (see Appendix A11 for details about general AIMS in-house procedures for data security, data quality checking and backup).

It is AIMS policy that all data collected have a metadata record created for it. The metadata record is created using a Metadata Entry System where the metadata is in the form of ISO19139 XML. This is the chosen format for many agencies across Australia and the international community that deal with spatial scientific data.

Metadata are available here:

<https://apps.aims.gov.au/metadata/view/c30cfb2d-46be-4837-9733-9bb60489b65b>

All coral monitoring field data is recorded on pre-printed datasheets. The use of standard datasheets aids in ensuring standard recording of attributes and makes sure that required data are collected.

On return from the field, all data is entered on the same day into a SQLite database using a custom written data entry program. Each field on the data entry program forms mirror those on the pre-printed datasheets and includes lookup fields to make sure that data entered is of

the appropriate structure or within predetermined limits. For example, entry of genera to the demography data table must match a pre-determined list of coral genera.

On return to the office, the data is uploaded to an Oracle Database using a custom written synchronisation process. All keyed data is printed and checked against field datasheets before final logical checking (ensuring all expected fields are included and tally with the number of surveys). Photo images are also stored on a server that is included in a routine automatic backup schedule. Photo images are copied to an external hard drive before analysis as a second backup.

Image analysis of reef monitoring photos is performed within the AIMS monitoring data entry package “reefmon”. This software contains logical checks to all keyed data and is directly linked to a database to guarantee data integrity. The directory path to transect images is recorded in the database. This functionality allows the checking of benthic category identification. All photo transect data is checked by a second experienced observer before data analysis and reporting of results.

#### **5.4 Summary of Quality Control measures**

Quality control is achieved by:

- Use of published SOPs.
- Data collection staff are trained and assessed by experienced observers before commencing field work to make sure that their identification skills are consistent with the resolution required.
- Data entry via database forms that include logical checking on format and content of entered fields, and confirmation of data by second observer.
- Continual evaluation, method development and improvement of methods.
- Advanced data management and security procedures.

## 6 Inshore seagrass monitoring

<sup>1</sup>Len McKenzie, <sup>2</sup>Michelle Waycott, <sup>3</sup>Richard Unsworth, <sup>1</sup>Catherine Collier

<sup>1</sup>Centre for Tropical Water & Aquatic Ecosystem Research (TropWATER), James Cook University, Cairns, QLD

<sup>2</sup> University of Adelaide / Plant Biodiversity Centre, Department of Environment and Natural Resources, Adelaide, SA

<sup>3</sup>Seagrass Ecosystem Research Group, College of Science, Wallace Building, Swansea University SA2 8PP, UK

### 6.1 Introduction

Approximately 3,464 square kilometres of inshore seagrass meadows have been mapped in Great Barrier Reef World Heritage Area waters shallower than 15 metres, relatively close to the coast, and in locations that can potentially be influenced by adjacent land use practices. Monitoring of the major marine ecosystem types most at risk from land-based sources of pollutants is being conducted to make sure that any change in their status is identified. Seagrass monitoring sites are associated with the river mouth and inshore marine water quality monitoring tasks in the MMP to enable correlation with concurrently collected water quality information.

The key aims of the inshore seagrass monitoring under the MMP are to:

- Monitor, assess and report the condition and trend of Great Barrier Reef inshore seagrass meadows against desired outcomes along identified or expected gradients in water quality.
- Monitor, assess and report the extent, frequency and intensity of acute and chronic impacts on the condition of Great Barrier Reef inshore seagrass meadows from sediments, nutrients and pesticides.
- Monitor, assess and report recovery of Great Barrier Reef inshore seagrass meadows from exposure to flood plumes, sediments, nutrients and pesticides.

### 6.2 Methods

#### 6.2.1 Sampling design

The sampling design was selected to detect changes in inshore seagrass meadows in response to improvements in water quality associated with specific catchments or groups of catchments (NRM region) and to disturbance events. Within each region, a relatively homogenous section of a representative seagrass meadow is selected to represent each of the seagrass habitats present (estuarine, coastal, reef, intertidal, subtidal). Meadow selection was informed using mapping surveys across the regions before site establishment and by the Authority, using advice from expert working groups. To account for spatial heterogeneity, two sites are selected within each location (Site [Habitat (Region)]). Subtidal sites are not replicated within all locations. Within each site, finer scale variability is accounted for by assessing 33 quadrats. The final constraint on site selection is that the minimum detectable relative difference (MDRD) must be below 20 per cent (at the 5 per cent

level of significance with 80 per cent power). An intertidal site is defined as a 5.5 hectare area and in the centre of each site a 50 m × 50 m area is examined using 33 quadrats (50 cm × 50 cm), placed every five metres along three 50 metre tape measures, placed 25 metres apart. A pilot assessment is conducted prior to establishing long-term monitoring to ensure no spatial autocorrelation within or between transects. The sampling strategy for subtidal sites is modified for drop-camera assessments. Drop-camera sampling is conducted from a surface vessel using a real-time underwater GoPro® camera mounted to a frame with a 0.25 m<sup>2</sup> quadrat in the field of view. The drop-camera is deployed within a 50 metre radius of permanent waypoints, using vertical drops and the footage recorded for post-field analysis. At sites which were originally assessed on SCUBA, the drop-camera is deployed along 50-metre transects two-to-three metres apart (aligned along the depth contour). A van Veen grab is used in conjunction with the visual assessment to confirm seagrass taxonomy and sediment type. At each site, monitoring is conducted during the late-monsoon (April) and late-dry (October) periods each year; extra sampling is conducted at more accessible locations in the dry (July) and monsoon (January) periods.

## **6.2.0 Field survey methods**

### **Site marking**

The sampling locations for this program are shown in Figure 6-1 and listed in Table 6-1. Where possible, each selected inshore intertidal seagrass site is permanently marked with a plastic star picket at the start of the centre transect. Labels identifying the sites and contact details for the program are attached to these pickets. Positions of zero metre and 50 metre points for all transects at a site are also noted using GPS (accuracy ±3 m). The centre of each subtidal site is marked with a waypoint (accuracy ±3 m). This guarantees that the same site is monitored at each event.

### **Seagrass cover and species composition**

Survey methodology follows standardised protocols (weblink <https://www.seagrasswatch.org/seagrass-monitoring/>). A site is defined as an area within a relatively homogenous section of a representative seagrass community/meadow (McKenzie *et al.* 2000).

Monitoring at the 47 sites identified for the MMP long-term inshore monitoring in late-monsoon (April) and late-dry season (October) of each year is conducted by qualified and trained scientists who have demonstrated competency in the methods (see Sub-section 6.2.1).



Figure 6-1 Inshore seagrass locations that exist as of 2022–23. However, not all locations were assessed or sampled in 2022–23.

Table 6-1 Inshore seagrass long-term monitoring sites surveyed in 2022–23

NRM region from www.nrm.gov.au. \* = intertidal, ^=subtidal.

	NRM region	Basin	Monitoring location	Site	Longitude	Latitude	Seagrass community type	
Far Northern	Cape York	Jacky Jacky / Olive-Pascoe	Shelburne Bay coastal	SR1*	Shelburne Bay	142.914	-11.887	<i>H. ovalis</i> with <i>H. uninervis</i> / <i>T. hemprichii</i>
				SR2*	Shelburne Bay	142.916	-11.888	<i>H. ovalis</i> with <i>H. uninervis</i> / <i>T. hemprichii</i>
			Piper Reef reef	FR1*	Farmer Is.	143.234	-12.256	<i>T. hemprichii</i> with <i>C. rotundata</i> / <i>H. ovalis</i>
				FR2*	Farmer Is.	143.236	-12.257	<i>T. hemprichii</i> with <i>C. rotundata</i> / <i>H. ovalis</i>
		Normanby / Jeannie	Flinders Group reef	ST1*	Stanley Island	144.245	-14.143	<i>H. ovalis</i> / <i>H. uninervis</i> with <i>T. hemprichii</i> / <i>C. rotundata</i>
				ST2*	Stanley Island	144.243	-14.142	<i>H. ovalis</i> / <i>H. uninervis</i> with <i>T. hemprichii</i> / <i>C. rotundata</i>
			Bathurst Bay coastal	BY1*	Bathurst Bay	144.233	-14.268	<i>H. uninervis</i> with <i>H. ovalis</i> / <i>T. hemprichii</i> / <i>C. rotundata</i>
				BY2*	Bathurst Bay	144.232	-14.268	<i>H. uninervis</i> with <i>H. ovalis</i> / <i>T. hemprichii</i> / <i>C. rotundata</i>
Northern	Wet Tropics	Daintree	Low Isles reef	LI1*	Low Isles	145.565	-16.385	<i>H. ovalis</i> / <i>H. uninervis</i>
				LI2^	Low Isles	145.564	-16.383	<i>H. ovalis</i> / <i>H. uninervis</i>
			Yule Point coastal	YP1*	Yule Point	145.512	-16.569	<i>H. uninervis</i> with <i>H. ovalis</i>
		YP2*		Yule Point	145.509	-16.564	<i>H. uninervis</i> with <i>H. ovalis</i>	
		Green Island reef		G1*	Green Island	145.973	-16.762	<i>C. rotundata</i> / <i>T. hemprichii</i> with <i>H. uninervis</i> / <i>H. ovalis</i>
			G2*	Green Island	145.976	-16.761	<i>C. rotundata</i> / <i>T. hemprichii</i> with <i>H. uninervis</i> / <i>H. ovalis</i>	
			G3^	Green Island	145.973	-16.755	<i>C. rotundata</i> / <i>H. uninervis</i> / <i>O. serrulata</i> / <i>S. isoetifolium</i>	
		Mission Beach coastal	LB1*	Lugger Bay	146.093	-17.961	<i>H. uninervis</i>	
			LB2*	Lugger Bay	146.094	-17.961	<i>H. uninervis</i>	
			Dunk Island reef	DI1*	Dunk Island	146.141	-17.944	<i>H. uninervis</i> with <i>T. hemprichii</i> / <i>C. rotundata</i>
				DI2*	Dunk Island	146.141	-17.946	<i>H. uninervis</i> with <i>T. hemprichii</i> / <i>C. rotundata</i>
		DI3^	Dunk Island	146.140	-17.932	<i>H. uninervis</i> / <i>H. ovalis</i> / <i>H. decipiens</i> / <i>O. serrulata</i>		
		Central	Burdekin	Ross / Burdekin	Magnetic Island reef	MI1*	Picnic Bay	146.841
MI2*	Cockle Bay					146.829	-19.177	<i>O. serrulata</i> / <i>H. uninervis</i> with <i>T. hemprichii</i> / <i>H. ovalis</i>
MI3^	Picnic Bay					146.841	-19.179	<i>H. uninervis</i> with <i>H. ovalis</i> & <i>Nanozostera</i> / <i>T. hemprichii</i>
Townsville coastal	SB1*				Shelley Beach	146.771	-19.186	<i>H. uninervis</i> with <i>H. ovalis</i>
	BB1*				Bushland Beach	146.683	-19.184	<i>H. uninervis</i> with <i>H. ovalis</i>
Bowling Green Bay coastal	JR1*				Jerona (Barratta CK)	147.241	-19.423	<i>H. uninervis</i> with <i>Nanozostera</i> / <i>H. ovalis</i>
	JR2*			Jerona (Barratta CK)	147.240	-19.421	<i>H. uninervis</i> with <i>Nanozostera</i> / <i>H. ovalis</i>	
Mackay-Whitsunday	Proserpine / O'Connell			Lindeman Is. reef	LN1^	Lindeman Is.	149.028	-20.438
			LN2^		Lindeman Is.	149.032	-20.434	<i>H. uninervis</i> with <i>H. ovalis</i>
			Repulse Bay coastal	MP2*	Midge Point	148.702	-20.635	<i>Nanozostera</i> with <i>H. uninervis</i> / <i>H. ovalis</i>
				MP3*	Midge Point	148.705	-20.635	<i>Nanozostera</i> with <i>H. uninervis</i> / <i>H. ovalis</i>
			Hamilton Island reef	HM1*	Hamilton Island	148.957	-20.344	<i>H. uninervis</i> with <i>H. ovalis</i>
HM2*	Hamilton Island		148.971	-20.347	<i>N. muelleri</i> with <i>H. ovalis</i> / <i>H. uninervis</i>			

	NRM region	Basin	Monitoring location	Site	Longitude	Latitude	Seagrass community type		
Southern		Plane	Sarina Inlet estuarine	SI1*	Sarina Inlet	149.304	-21.396	<i>N. muelleri</i> with <i>H. ovalis</i> ( <i>H. uninervis</i> )	
				SI2*	Sarina Inlet	149.305	-21.395	<i>N. muelleri</i> with <i>H. ovalis</i> ( <i>H. uninervis</i> )	
		Fitzroy	Shoalwater Bay / Fitzroy	Shoalwater Bay coastal	RC1*	Ross Creek	150.213	-22.382	<i>Nanozostera muelleri</i> with <i>H. ovalis</i>
					WH1*	Wheelans Hut	150.275	-22.397	<i>Nanozostera muelleri</i> with <i>H. ovalis</i>
				Keppel Islands reef	GK1*	Great Keppel Is.	150.939	-23.196	<i>H. uninervis</i> with <i>H. ovalis</i>
					GK2*	Great Keppel Is.	150.940	-23.194	<i>H. uninervis</i> with <i>H. ovalis</i>
		Calliope / Boyne	Gladstone Harbour estuarine		GH1*	Gladstone Hbr	151.301	-23.767	<i>Nanozostera muelleri</i> with <i>H. ovalis</i>
					GH2*	Gladstone Hbr	151.304	-23.765	<i>Nanozostera muelleri</i> with <i>H. ovalis</i>
		Burnett-Mary	Baffle	Rodds Bay estuarine	RD1*	Rodds Bay	151.655	-24.058	<i>Nanozostera muelleri</i> with <i>H. ovalis</i>
						RD3*	Rodds Bay	151.589	-24.038
			Burrum	Burrum Heads coastal	BH1*	Burrum Heads	152.626	-25.188	<i>H. uninervis</i> / <i>Nanozostera</i> with <i>H. ovalis</i>
						BH3*	Burrum Heads	152.639	
			Mary	Hervey Bay estuarine	UG1*	Urangan	152.907	-25.301	<i>Nanozostera muelleri</i> with <i>H. ovalis</i>
						UG2*	Urangan	152.906	-25.303

Table 6-2 Extra inshore seagrass long-term monitoring sites from the Seagrass-Watch and QPWS drop-camera programs surveyed in 2022–23. NRM region from www.nrm.gov.au. \* = intertidal, ^ = subtidal.

Region	NRM region	Basin	Monitoring location	Site	Longitude	Latitude	Seagrass community type	
Far Northern	Cape York	Jacky	Margaret Bay <i>coastal</i>	MA1	Margaret Bay	143.194	-11.957	<i>H. uninervis</i> / <i>H. ovalis</i> with <i>H. spinulosa</i>
				MA2	Margaret Bay	143.203	-11.956	
		Lockhart	Lloyd Bay <i>coastal</i>	LR1^	Lloyd Bay	143.485	-12.797	<i>H. uninervis</i> / <i>H. ovalis</i> with <i>H. spinulosa</i>
				LR2^	Lloyd Bay	143.475	-12.825	
		Normanby / Jeannie	Flinders Group <i>reef</i>	FG1^	Flinders Island	144.225	-14.182	<i>H. uninervis</i> / <i>H. ovalis</i> with <i>H. spinulosa</i>
				FG2^	Flinders Island	144.225	-14.182	
	Bathurst Bay <i>coastal</i>	BY3^	Bathurst Bay	144.285	-14.276	<i>H. uninervis</i> with <i>H. ovalis</i>		
		BY4^	Bathurst Bay	144.300	-14.275			
Northern	Wet Tropics	Tully / Murray / Herbert	Missionary Bay <i>coastal</i>	MS1^	Missionary Bay	146.213	-18.216	<i>H. uninervis</i> with <i>H. ovalis</i>
				MS2^	Missionary Bay	146.217	-18.205	
Central	Burdekin	Ross / Burdekin	Townsville <i>coastal</i>	SB2*	Shelley Beach	146.763	-19.182	<i>H. uninervis</i> with <i>H. ovalis</i>
		Don	Bowen <i>coastal</i>	BW1*	Port Dennison	148.250	-20.017	<i>Nanozostera</i> / <i>H. uninervis</i> with <i>H. ovalis</i>
	BW2*			Port Dennison	148.252	-20.017		
	Don	Shoal Bay <i>reef</i>	HB1*	Hydeaway Bay	148.482	-20.075	<i>H. uninervis</i> / <i>C. rotundata</i> / <i>T. hemprichii</i> with <i>H. ovalis</i>	
			HB2*	Hydeaway Bay	148.481	-20.072		
	Proserpine	Pioneer Bay <i>coastal</i>	PI2*	Pioneer Bay	148.693	-20.269	<i>Nanozostera</i> / <i>H. uninervis</i> with <i>H. ovalis</i>	
			PI3*	Pioneer Bay	148.698	-20.271		
	Proserpine / O'Connell	Whitsunday Island <i>reef</i>	TO1^	Tongue Bay	149.016	-20.240	<i>H. uninervis</i> / <i>T. hemprichii</i> with <i>H. ovalis</i>	
			TO2^	Tongue Bay	149.012	-20.242		
		St Helens Bay <i>coastal</i>	SH1*	St Helens Bch	148.835	-20.822	<i>H. uninervis</i> / <i>Nanozostera</i> with <i>H. ovalis</i>	
			Newry Islands <i>coastal</i>	NB1^	Newry Bay	148.926	-20.868	<i>H. uninervis</i> with <i>H. ovalis</i> / <i>H. spinulosa</i>
	NB2^	Newry Bay		148.924	-20.872			
Plane	Clairview <i>coastal</i>	CV1*	Clairview	149.533	-22.104	<i>H. uninervis</i> / <i>Nanozostera</i> with <i>H. ovalis</i>		
		CV2*	Clairview	149.535	-22.108			

At each intertidal site, during each survey, observers record the per cent seagrass cover within a 50 cm × 50 cm quadrat every five metres along three 50 metre transects, placed 25 metres apart. A total of 33 quadrats are sampled per intertidal site. Seagrass abundance is visually estimated as the fraction of the seabed (substrate) obscured by the seagrass species leaves (living) when submerged and viewed from above. This method is used because the technique has wider application and is very quick, requiring only minutes at each quadrat; yet it is robust and highly repeatable, thereby minimising among-observer differences. Quadrat per cent cover measurements have also been found to be far more efficient in detecting differences in seagrass abundance than seagrass blade counts or measures of above- or below-ground biomass. To improve resolution and allow greater differentiation at very low percentage covers (e.g. < three per cent), shoot counts based on global species density maxima are used. For example: 1 pair of *Halophila ovalis* leaves in a quadrat = 0.1%; 1 shoot/ramet of *Nanozostera* in a quadrat = 0.2%. Extra information is collected at the quadrat level, including seagrass canopy height of the dominant strap leaved species; macrofaunal abundance; abundance of burrows, as a measure of bioturbation; presence of herbivory (for example dugong and sea turtle); a visual/tactile assessment of sediment composition (McKenzie 2007) and observations on the presence of superficial sediment structures such as ripples and sand waves to provide evidence of physical processes in the area (Koch 2001). For sites assessed using drop-cameras, the digital video footage is examined post-field and seagrass abundance is visually estimated as the fraction of the seabed (substrate) obscured by the seagrass species for each clearly visible drop to the sea bed. Due to the turbid/low light conditions in the field, some post-processing may be necessary to enhance image features and improve assessments. Species visible in imagery are verified from van Veen grab samples.

Monitoring at an extra 33 sites is conducted during the late-dry season by trained Seagrass-Watch observers (scientists assisted by community volunteers) or QPWS rangers who have demonstrated competency in the methods (see Sub-section 6.2.1; Table 6-2). Seagrass-Watch observers monitor sites using standard protocols; however, QPWS rangers use drop-cameras to collect basic site data and field imagery that is submitted to JCU scientists for post-field assessments.

### **Seagrass reproductive health**

An assessment of seagrass reproductive health at locations identified in Table 6-1 via flower production and seed bank monitoring is conducted at each site each sampling event.

In the field, 15 haphazardly placed cores (100 mm diameter × 100 mm depth) of seagrass are collected from an area adjacent, of similar cover and species composition, to each monitoring site. All samples collected are given a unique sample code/identifier providing a custodial trail from the field sample to the analytical outcome.

Seeds banks and the abundance of germinated seeds are sampled according to standard methods by sieving (1 mm mesh) 30 cores (50 mm diameter, 100 mm depth) of sediment collected across each site and counting the seeds retained in each (McKenzie *et al.* 2000). For *Nanozostera muelleri*, where the seeds are <1 mm diameter, intact cores (18) are collected and returned to the laboratory where they are washed through a 710 µm sieve and seeds identified using a hand lens/microscope.

## Meadow extent

Mapping the edge of the seagrass meadow within each monitoring site (i.e., 5.5 hectares) is conducted in both the late-dry (October) and late-monsoon (April) monitoring periods at all sites identified in Table 6-1. Training and equipment (GPS) are provided to personnel involved in the edge mapping.

Mapping methodology follows standard methodology (<https://www.seagrasswatch.org/seagrass-monitoring/>) (McKenzie *et al.* 2001). Meadow, patch, or scar (meadow-scape) edges are recorded as tracks (one second polling) or a series of waypoints in the field using a portable GPS receiver (i.e. Garmin GPSmap® 60CSx or 62s). Accuracy in the field is dependent on the portable GPS receiver (Garmin GPSmap® 60CSx is <15 metres RMS95 per cent (DGPS (USCG) accuracy: 3–5 metres, 95 per cent typical) and how well the edge of the meadow is defined. Generally, accuracy is within that of the GPS (i.e. 3–5 metres) and datum used is WGS84. Tracks and waypoints are downloaded from the GPS to a portable computer using MapSource or BaseCamp software as soon as practicable (preferably on returning from the day's activity) and exported as \*.dxf files to ESRI® ArcGIS™.

Field mapping procedures at subtidal sites are altered to suit the low visibility conditions and the requirement to map by drop-camera. From the central picket (deployment location of light and turbidity loggers) straight lines of approximately 50 m lengths are traversed at an angle of 45 degrees from each other. The drop-camera and frame are a sequentially lowered and raised to and from the seabed as the boat traverses at drifting speed. As a consequence, the frame “hops” along the seabed, and the camera records images in time-lapse mode every 2 seconds. A GPS on the vessel records the track, which polls every 1 second. Prior to deployment of the camera and frame, the camera records an image of the GPS display, to record the timestamp: this enables synchronisation of the images with the GPS to geotag each image. Eight lines at approximately 45 degrees are performed, with the first following the orientation of the monitoring transects; the others are undertaken at 45 degree angles from the first.

### 6.2.1 Observer training

The JCU personnel collecting data in association with this project are without exception highly experienced in the collection of seagrass monitoring data. The majority of observers have been involved in seagrass monitoring for at least a decade and were employed specifically for their skills associated with the tasks required.

All observers have successfully completed a Level 1 Seagrass-Watch training course ([seagrasswatch.org/training.html](http://seagrasswatch.org/training.html)) and have demonstrated competency across nine core units, achieved 80 per cent of formal assessment (classroom and laboratory) (5 units) and demonstrated competency in the field both during the workshop (1 unit) and post workshop (3 units = successful completion of 3 monitoring events/periods within 12 months). Volunteers who assist JCU scientists have also successfully completed a Level 1 training course.

Technical issues concerning QC of data are important and are resolved by using standard methods that make sure of completeness in the field (the comparison between the amounts of valid or useable data originally planned to collect versus how much were collected); using standard seagrass cover calibration sheets to guarantee precision (the degree of agreement

among repeated measurements of the same characteristic at the same place and the same time) and consistency between observers and across sites at monitoring times. Ongoing standardisation of observers is achieved through routine comparisons during sampling events. Any discrepancy is used to identify and subsequently mitigate bias. For the most part, however, uncertainties in per cent cover or species identification are mitigated in the field via direct communication or by the collection of voucher specimens (to be checked under a microscope and pressed in the herbarium) and the use of a digital camera to record images (protocol requires that all quadrats are photographed) for later identification and discussion. Evidence of competency is securely filed on a secure server at Seagrass-Watch HQ.

## 6.2.2 Laboratory analysis

### Seagrass reproductive health

In the laboratory, reproductive structures (spathes, fruits, female flowers or male flowers; Figure 6-2) of plants from each core are identified and counted for each sample and species. If *Halodule uninervis* seeds (brown/green colour) are still attached to the rhizome, they are counted as fruits. Seed estimates are not recorded for *Halophila ovalis* due to time constraints (if time is available post this first pass of the samples, fruits are dissected and seeds counted). For *Nanozostera muelleri*, the number of spathes is recorded, and male and female flowers and seeds are counted during dissection if there is time after the initial pass of the samples. Apical meristems are counted if possible. The number of nodes for each species is counted, and for each species present in the sample, 10 random internode lengths and 10 random leaf widths are measured. Approximately five per cent of samples are cross-calibrated between technicians. All samples, including flowers and spathes and fruits/fruitlet bodies are kept and re-frozen in the site bags for approximately two years for revalidation if required. Reproductive effort is calculated as the number of reproductive structures per core.

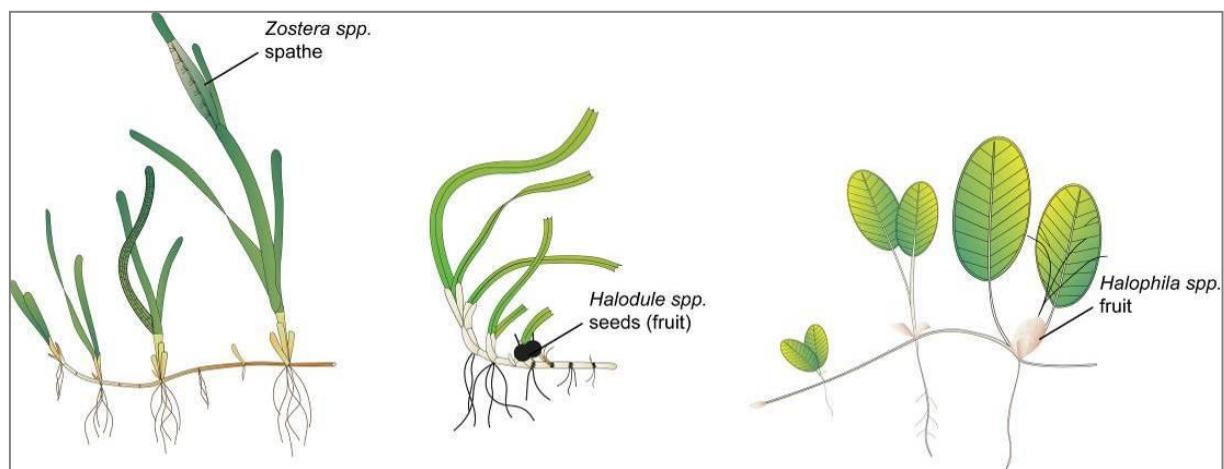

Figure 6-2 Form and size of reproductive structure of the seagrasses collected: *Halophila ovalis*, *Halodule uninervis* and *Nanozostera muelleri*.

### Meadow extent

Mapping is conducted by trained and experienced scientists using ESRI® ArcMap™ 10.8 (Environmental Systems Research Institute, ArcGIS™ Desktop 10.8). Boundaries of

meadows/patches are determined based on the positions of the geotagged photos and the presence of seagrass. Edges are mapped using the polyline feature to create a polyline (i.e. 'join the dots'), which is then smoothed using the B-spline algorithm. The smoothed polyline is then converted to a polygon and saved as a shapefile. The coordinate system (map datum) used for projecting the shapefile is AGD94.

In certain cases, seagrass meadows form very distinct edges that remain consistent over many growing seasons. However, in other cases the seagrass landscape tends to grade from dense continuous cover to no cover over a continuum that includes small patches and shoots of decreasing density. Boundary edges in patchy meadows are vulnerable to interpreter variation, however, the general rule is that a boundary edge is determined where there is a gap with the distance of more than three metres (i.e. accuracy of the GPS). Final shapefiles are overlaid with aerial photographs and base maps (AusLig™) to assist with illustration/presentation.

The expected accuracy of the map product gives some level of confidence in using the data. Using GIS, meadow boundaries are assigned a quality value based on the type and range of mapping information available for each site and determined by the distance between waypoints and GPS position fixing error. These meadow boundary errors are used to estimate the likely range of area for each meadow mapped (Lee Long *et al.* 1997).

### **6.2.3 Temperature monitoring within seagrass canopy**

Autonomous iBTag™ submersible temperature loggers are deployed at all sites identified in Table 6-1. The loggers record temperature (degrees Celsius) within the seagrass canopy every 30 to 90 minutes (depending on the duration of deployment and logger storage capacity) and store data in an inbuilt memory, which is downloaded every three to twelve months, depending on the site.

The iBCod 22L model of iBTag™ loggers is used as it can withstand prolonged immersion in salt water to a depth of 600 metres. It is reinforced with solid titanium plates and over moulded in a tough polyurethane casing that can take a lot of rough handling.

The main features of the iBCod 22L include:

- operating temperature range: -40 to +85°C
- resolution of readings: 0.5°C or 0.0625°C
- accuracy: ±0.5°C from -10°C to +65°C
- sampling Rate: 1 second to 273 hours
- number of readings: 4096 or 8192 depending on configuration
- password protection, with separate passwords for read only and full access.

The large capacity of this logger allows the collection of 171 days of readings at 30 minute intervals.

The iBCod 22 litre submersible temperature loggers are placed at a permanent marker at each site for three to six months (depending on monitoring frequency). Loggers are attached to the permanent station marker using cable ties, above the sediment-water interface. This location

makes sure that the sensors are not exposed to air unless the seagrass meadow is completely drained and places them out of sight of curious people.

Each logger has a unique serial number that is recorded within a central secure database. The logger number is recorded on the monitoring site datasheet with the time of deployment and collection. At each monitoring event (every three to six months), the iBTag™ temperature loggers are removed and replaced with a fresh logger (these are dispatched close to the monitoring visit). After collection, details of the logger number, field datasheet (with date and time) and logger are returned for downloading.

Logger deployment and data retrieval are carried out by JCU professional and technical personnel who have been trained in the applied methods. Methods and procedures documents are available to relevant staff and are collectively kept up to date. Changes to procedures are developed and discussed and recorded in metadata records.

#### 6.2.4 Light monitoring at seagrass meadow canopy

Autonomous light loggers are deployed at selected nearshore and offshore seagrass sites in all regions monitored (Table 6-3).

Submersible Odyssey™ photosynthetic irradiance loggers are placed at the permanent marker at each of the sites for three to six month periods (depending on monitoring frequency).

Odyssey™ data loggers (Odyssey, Christchurch, New Zealand) record photosynthetically active radiation (400–1100 nm) and store data in an inbuilt memory, which is retrieved every three to six months, depending on the site. Each logger has the following technical specifications:

- cosine corrected photosynthetic irradiance sensor 400–700 nm
- cosine corrected solar irradiance sensor 400–1100 nm
- integrated count output recorded by Odyssey data recorder
- user defined integration period
- submersible to 20-metre water depth
- 64 k memory.

Table 6-3 Monitoring sites selected for light logger data collection.

Region	Basin	Water body	Site	Latitude		Longitude	
Cape York	Jacky Jacky / Olive-Pascoe	Enclosed Coastal intertidal	Shelburne Bay	-11°	53.251	142°	54.938
		Midshelf intertidal	Piper Reef	-12°	15.352	143°	14.020
	Normanby / Jeannie	Open coastal intertidal	Stanley Island	-14°	8.576	144°	14.680
			Bathurst Bay	-14°	16.062	144°	13.896
North	Daintree	Midshelf intertidal & subtidal	Low Isles	-16°	23.11	145°	33.88

Region	Basin	Water body	Site	Latitude		Longitude	
	Mossman / Barron / Mulgrave-Russell / Johnstone	Midshelf intertidal & subtidal	Green Island	-16°	45.789	145°	58.31
		Enclosed Coastal intertidal	Yule Point	-16°	34.159	145°	30.744
	Tully / Murray / Herbert	Open coastal intertidal & subtidal	Dunk Island	-17°	56.75	146°	08.45
Central	Ross / Burdekin	Open coastal intertidal & subtidal	Picnic Bay	-19°	10.734	146°	50.468
			Cockle Bay	-19°	10.612	146°	49.737
		Enclosed coastal intertidal	Bushland Beach	-19°	11.028	146°	40.951
			Barratta Creek	-19°	25.380	147°	14.480
	Proserpine / O'Connell	Open coastal intertidal & subtidal	Hamilton Island	-20°	20.802	148°	58.246
			Lindeman Island	-20°	26.293	149°	1.691
		Enclosed coastal intertidal	Midge Point	-20°	38.099	148°	42.108
	Plane	Enclosed coastal intertidal	Sarina Inlet	-21°	23.76	149°	18.2
Southern	Shoalwater / Fitzroy	Open coastal intertidal	Great Keppel Island	-23°	11.7834	150°	56.3682
		Macro tidal Enclosed coastal intertidal	Shoalwater Bay	-22°	23.926	150°	16.366
	Calliope / Boyne	Enclosed coastal intertidal	Gladstone Harbour	-23°	46.005	151°	18.052
	Baffle	Enclosed coastal intertidal	Rodds Bay	-24°	4.866	151°	39.7584
	Burrum	Enclosed coastal intertidal	Burrum Heads	-25°	11.290	152°	37.532
	Mary	Enclosed coastal intertidal	Urangan	-25°	18.197	152°	54.364

The logger is self-contained in a pressure-housing with batteries providing sufficient power for deployments of longer than six months. For field deployment, loggers are attached to a permanent station marker using cable ties; this is above the sediment-water interface at the bottom of the seagrass canopy. Similar to the submersible temperature loggers, this location makes sure that the sensors are not exposed to air unless the seagrass meadow is almost completely drained and places them out of sight of curious people. At subtidal sites, the loggers are deployed on the sediment surface (attached to a permanent marker) with the sensor at seagrass canopy height. Two loggers are deployed at subtidal sites as there is an increased

chance of logger fouling, and the dual logger set-up offers a redundant dataset in the instance that one logger fouls completely. Where possible, extra light loggers are deployed at subtidal sites 80 centimetres from the sediment surface. Data from this logger, together with data from the logger at canopy height, is used for calculation of the light attenuation co-efficient. Furthermore, another logger is deployed above the water surface at each of the subtidal monitoring stations. These extra loggers (surface and subtidal higher in the water column) allow comparison of water quality indices for some of the time.

Measurements are recorded by the logger every 30 minutes (this is a cumulative 30 minute reading). Experiments utilising loggers with and without wipers have been conducted to determine the benefits of wiper use and it was confirmed that the wipers improved the quality of the data by keeping the sensor free from fouling. Automatic wiper brushes are attached to each logger to clean the optical surface of the sensor every 15 minutes to prevent marine organisms fouling the sensor or sediment settling on the sensor, both of which diminish the light reading.

Each light logger has a unique serial number that is recorded within a central secure database. The logger number is recorded on the monitoring site datasheet with the time of deployment and collection. At each monitoring event (every three to six months) the light loggers are removed and replaced with a 'fresh' logger. At subtidal monitoring sites, the loggers are checked by scuba by JCU personnel (and replaced if fouled) every three months due to the increased fouling rates at permanently submerged sites. After collection, details of the logger number, field datasheet (with date and time) and logger are returned to JCU for downloading.

Photographs of the light sensor and/or notes on the condition of the sensor are recorded at logger collection. If fouling is major (e.g. wiper failure), data are truncated to include only that data before fouling began — usually one to two weeks. If fouling was minor (up to ~25 per cent of the sensor covered), back corrections to the data are made to allow for a linear rate of fouling (linear because with minor fouling it is assumed that the wiper was retarding algal growth rates, but not fully inhibiting them).

### **6.2.5 Light logger calibration procedure**

Loggers are calibrated against a certified reference photosynthetically active radiation sensor (Li-Cor™ Li-192SB Underwater Quantum Sensor) against a Li-Cor light source under controlled laboratory conditions.

The Li-192SB sensor is cosine corrected and specifications are:

- absolute calibration:  $\pm 5$  per cent in air
- relative error:  $< \pm 5$  per cent under most conditions
- sensitivity: typically  $3 \mu\text{A}$  per  $1000 \mu\text{E s}^{-1} \text{m}^{-2}$  in water.

The reference light sensor is calibrated before deployment by JCU. The calibration of each logger is recorded within metadata and corresponds to the serial numbers attached to each logger. The calibration is performed in air and a 1.33 conversion factor is applied to the data to allow for the difference in light transmission to the sensor between air and water (Kirk 1994). This factor is not applied when the sensor is immersed at low tide and emersion is estimated from actual sea level data provided by Maritime Safety Queensland.

Logger deployment and data retrieval is carried out by scientific personnel who have been trained in the applied methods. Methods and procedures documents are available to relevant staff and are collectively kept up to date. Changes to procedures are developed and discussed and recorded in metadata records.

### **6.3 Data management**

#### **6.3.1 Meadow abundance, community structure, reproductive health and extent**

TropWATER has systems in place to manage the way MMP data are collected, organised, documented, evaluated and secured. All data are collected and collated in a standard format. Seagrass-Watch HQ has implemented a QA management system to make sure that the data collected are organised and stored and able to be easily used.

All data (datasheets and photographs) received are entered into a secure relational database. Receipt of all original data hardcopies is documented and filed within the Seagrass-Watch HQ File Management System, a formally organised and secure system. The database is routinely backed up (in multiple places). Seagrass-Watch HQ operates as custodian of data collected and provides an evaluation and analysis of the data for reporting purposes. Access to the IT system and databases is restricted to only authorised personnel.

Seagrass-Watch HQ performs a quality check on the data. Seagrass-Watch HQ provides validation of data and attempts to correct incidental/understandable errors where possible (for example blanks are entered as -1 or if monospecific meadow percentage composition = 100 per cent) (<https://www.seagrasswatch.org/seagrass-monitoring/>). Validation is provided by checking observations against photographic records to make sure of the consistency of observers and by identification of voucher specimens submitted.

Keeping to QA/QC protocols, Seagrass-Watch HQ informs observers via an official data error notification of any errors encountered/identified and provides an opportunity for correction/clarification (this may include extra training). Any data which does not pass QA/QC is quarantined or removed from the database.

After meadow extent field mapping, data points are downloaded from the GPS into computer memory and the data exported to ESRI® ArcGIS™. An administration file (\*.gdb) is generated by the MapSource or BaseCamp software that contains metadata information about the tracks, waypoints, dates and times of the measurements, as well as general comments. Data and metadata are stored on the TropWATER (JCU, Cairns campus) secure server.

#### **6.3.2 Temperature monitoring within seagrass canopy**

After retrieval, data are downloaded into computer memory and the data are displayed as graphs to allow visual identification of outliers. These outliers are then tagged and removed from the datasets (for example a temperature spike below -10°C or above 65°C). Other data adjustments include the removal of data points from the beginning and end of the data series, for example when the logger was not attached to the permanent peg. An administration file is generated by the logger software that contains metadata information about the deployment site,

dates and times of the start and stop of measurements, as well as general comments. Data and metadata are stored in a temporary Microsoft Access database.

Loggers are then launched for the next deployment. All data are transferred into the existing TropWATER database.

### **6.3.3 Light monitoring at seagrass meadow canopy**

After retrieval, data are downloaded into computer memory and the data are displayed as graphs to allow visual identification of outliers. These outliers are then tagged and removed from the datasets; however, such outliers have mostly not been present. During the placement and retrieval of the logger, the site or logger may suffer a short disturbance from the technician; adjustments are made to the data to remove a small number of data points from the beginning and end of the data series to account for this.

An administration file is generated by the logger software that contains metadata information about the deployment site, dates and times of the start and stop of measurements, as well as general comments. Data and metadata are stored in a temporary Microsoft® Access database.

Loggers are then launched for the next deployment. All data are transferred into the existing TropWater database.

JCU is also working on assigning values to the level of confidence in the data. For example, sometimes corrections are made to light data to account for minor fouling. We would like to add a code to the data that indicates that we have reduced confidence in it because we have made adjustments.

## **6.4 Summary of Quality Control measures**

### **6.4.1 Meadow abundance, community structure, reproductive health and extent**

- Training of field staff
- Sampling guidelines
- Document control
- Data download control
- Analytical QC measures
- QC of data entry
- Training of staff using ESRI® ArcGIS™ Desktop 10.8 software

### **6.4.2 Temperature monitoring within seagrass canopy**

- Training of deployment and retrieval staff
- Use of serial numbers to provide unique identification to individual loggers
- Data download control
- QC of data entry

### **6.4.3 Light monitoring at seagrass meadow canopy**

- Use of serial numbers to provide unique identification to individual loggers

- Training of deployment and retrieval staff
- Calibration of loggers with certified reference light sensor
- QC of data entry

## 7 References

Álvarez-Romero, J.G., Devlin, M., Teixeira da Silva, E., Petus, C., Ban, N.C., Pressey, R.L., Kool, J., Roberts, J.J., Cerdeira-Estrada, S., Wenger, A.S. and Brodie, J. 2013, A novel approach to model exposure of coastal-marine ecosystems to riverine flood plumes based on remote sensing techniques, *Journal of Environmental Management* 119: 194-207.

Australian and Queensland governments, 2024, Scoring system, Reef Water Quality Report Card 2021 and 2022, State of Queensland, Brisbane.

Australian and New Zealand Environment and Conservation Council (ANZECC) and Agriculture and Resource Management Council of Australia and New Zealand (ARMCANZ) 2000, *Australian and New Zealand guidelines for fresh and marine water quality, National Water Quality Management Strategy Paper No 4*, ANZECC and ARMCANZ, Canberra.

Australian and New Zealand Governments 2018, *Australian and New Zealand Guidelines for Fresh and Marine Water Quality*, Australian and New Zealand Governments and Australian state and territory governments, Canberra, ACT.

Bainbridge, Z.T., Wolanski, E., Álvarez-Romero, J.G., Lewis, S.E. and Brodie, J.E. 2012, Fine sediment and nutrient dynamics related to particle size and floc formation in a Burdekin River flood plume, Australia, *Marine Pollution Bulletin* 65(4): 236-248.

Baith, K., Lindsay, R., Fu, G. and McClain, C.R. 2001, Data analysis system developed for ocean color satellite sensors, *Eos, Transactions American Geophysical Union* 82: 202-218.

Booij, K., Vrana, B. and Huckins, J.N. 2007, Theory, modelling and calibration of passive samplers used in water monitoring, in *Passive sampling techniques in environmental monitoring*, eds R. Greenwood, G. Millis and B. Vrana, Elsevier Amsterdam, Amsterdam, pp. 141-169.

Brando, V.E., Schroeder, T. and Dekker, A.G. 2010, *Reef Rescue Marine Monitoring Program: using remote sensing for GBR wide water quality*. Final report for 2008/09 activities, CSIRO, Canberra.

Brando, V.E., Dekker, A.G., Park, Y.J. and Schroeder, T. 2012, Adaptive semianalytical inversion of ocean color radiometry in optically complex waters, *Applied Optics* 51(15): 2808-2833.

Brinkman, R., Tonin, H., Furnas, M., Schaffelke, B. and Fabricius, K. 2014, *Targeted analysis of the linkages between river runoff and risks for crown-of-thorns starfish outbreaks in the Northern GBR*: Report for Terrain NRM, Australian Institute of Marine Science, Townsville.

Collier, C., Devlin, M.J., Langlois, L., McKenzie, L., Petus, C., Texeira da Silva, E., McMahon, K., Adams, M., O'Brien, K., Statton, J. and Waycott, M. 2014, *Thresholds and indicators of declining water quality as tools for tropical seagrass management. Report to the National Environmental Research Program*, Reef and Rainforest Research Centre Limited, Cairns.

De'ath, G. and Fabricius, K.E. 2008, *Water quality of the Great Barrier Reef: Distributions, effects on reef biota and trigger values for the protection of ecosystem health*, Great Barrier Reef Marine Park Authority, Townsville.

Devlin, M. and Schaffelke, B. 2009, Spatial extent of riverine flood plumes and exposure of marine ecosystems in the Tully coastal region, Great Barrier Reef, *Marine and Freshwater Research* 60(11): 1109-1122.

Devlin, M., McKinna, L.W., Álvarez-Romero, J., Petus, C., Abott, B., Harkness, P. and Brodie, J. 2012. Mapping the pollutants in surface plume waters in the Great Barrier Reef, Australia. *Marine Pollution Bulletin* 65: 224-235.

Devlin, M., da Silva, E., Álvarez-Romero, J., Zeh, D., Waterhouse, J. and Brodie, J. 2013, Chapter 5. Mapping of exposure to flood plumes, water types and exposure to pollutants (DIN, TSS) in the Great Barrier Reef: toward the production of operational risk maps for the World's most iconic marine ecosystem. in *Assessment of the relative risk of water quality to ecosystems of the Great Barrier Reef: supporting studies. A report to the Department of the Environment and Heritage Protection*, Queensland Government, ed. J. Waterhouse, Centre for Tropical Water & Aquatic Ecosystem Research, James Cook University, Townsville.

Devlin, M.J., Petus, C., Da Silva, E., Tracey, D., Wolff, N.H., Waterhouse, J. and Brodie, J. 2015, Water quality and river plume monitoring in the Great Barrier Reef: an overview of methods based on ocean colour satellite data, *Remote Sensing* 7(10): 12909-12941.

Great Barrier Reef Marine Park Authority 2010, *Water Quality Guidelines for the Great Barrier Reef Marine Park*, Great Barrier Reef Marine Park Authority, Townsville.

Great Barrier Reef Marine Park Authority 2019, *Marine Monitoring Program: Quality Assurance and Quality Control Manual 2017-18*, Great Barrier Reef Marine Park Authority, Townsville.

Gruber, R., Waterhouse, J., Logan, M., Petus, C., Howley, C., Lewis, S., Tracey, D., Langlois, L., Tonin, H., Skuza, M., Costello, P., Davidson, J., Gunn, K., Wright, M., Zagorskis, I., Kroon, F. and Neilen, A. 2019, *Marine Monitoring Program: Annual Report for Inshore Water Quality Monitoring 2017-2018. Report for the Great Barrier Reef Marine Park Authority*, Great Barrier Reef Marine Park Authority, Townsville.

Haynes, D. and Michalek-Wagner, K. 2000, Water quality in the Great Barrier Reef World Heritage Area: past perspectives, current issues and new research directions, *Marine Pollution Bulletin* 41(7): 428-434.

Haynes, D.B., Brodie, J., Waterhouse, J., Bainbridge, Z., Bass, D. and Hart, B. 2007, Assessment of the water quality and ecosystem health of the Great Barrier Reef (Australia): conceptual models, *Environmental Management* 40(6): 993-1003.

Jeffrey, S.W. and Humphrey, G.F. 1975, New Spectrophotometric Equations for Determining Chlorophylls a, b, c1 and c2 in Higher Plants, Algae and Natural Phytoplankton, *Biochem. Physiol. Pflanzen (BBP)* 167, S.18020: 191-194.

Jenks, G.F. and Caspall, F.C. 1971, Error on choroplethic maps: definition, measurement, reduction, *Annals of the Association of American Geographers* 61(2): 217-244.

Jones, R., Ricardo, G. and Negri, A.P. 2015, Effects of sediments on the reproductive cycle of corals, *Marine Pollution Bulletin* 100(1): 13-33.

Jonker, M., Johns, K. and Osborne, K. 2008, *Surveys of benthic reef communities using underwater digital photography and counts of juvenile corals. Long-term Monitoring of the Great Barrier Reef. Standard Operational Procedure. No. 10.* Australian Institute of Marine Science, Townsville.

Kennedy, K., Bentley, C., Paxman, C., Dunn, A., Heffernan, A., Kaserzon, S. and Mueller, J. 2010, *Monitoring of organic chemicals in the Great Barrier Reef Marine Park using time integrated monitoring tools (2009-2010); Final Report*, National Research Centre for Environmental Toxicology (EnTox), University of Queensland, Brisbane.

Kingston, J.K., Greenwood, R., Mills, G.A., Morrison, G.M. and Persson, L.B. 2000, Development of a novel passive sampling system for the time-averaged measurement of a range of organic pollutants in aquatic environments, *Journal of Environmental Monitoring* 2(5): 487-495.

Kirk, J.T.O. 1994, *Light and photosynthesis in aquatic ecosystems*, 2nd edn, Cambridge University Press, Cambridge, UK.

Koch, E.W. 2001, Beyond light: Physical, geological and geochemical parameters as possible submersed aquatic vegetation habitat requirements, *Estuaries* 24: 1-17.

Kuhnert, P., Liu, Y., Henderson, B., Dambacher, J., Lawrence, E. and Kroon, F. 2015, *Review of the Marine Monitoring Program (MMP): Final report for the Great Barrier Reef Marine Park Authority (GBRMPA)*, CSIRO, Australia.

Lee Long, W.J., McKenzie, L.J. and Coles, R.G. 1997, *Seagrass communities in the Shoalwater Bay region, Queensland - Spring (September) 1995 and Autumn (April) 1996*, Great Barrier Reef Marine Park Authority, Townsville.

Margvelashvili, N., Andrewartha, J., Baird, M., Herzfeld, M., Jones, E., Mongin, M., Rizwi, F., Robson, B., Skerratt, J. and Wild-Allen, K. 2018, Simulated fate of catchment-derived sediment on the Great Barrier Reef shelf, *Marine Pollution Bulletin* 135: 954-962.

McKenzie, L.J. 2007, *Relationships between seagrass communities and sediment properties along the Queensland coast. Progress report to the Marine and Tropical Sciences Research Facility*, Reef and Rainforest Research Centre Limited, Cairns.

McKenzie, L.J., Lee Long, W.J., Coles, R.G. and Roder, C.A. 2000, Seagrass-watch: community based monitoring of seagrass resources, *Biologia Marina Mediterranea* 7(2): 393-396.

McKenzie, L.J., Finkbeiner, M.A. and Kirkman, H. 2001, Methods for mapping seagrass distribution. Chapter 5, in *Global Seagrass Research Methods*, eds F.T. Short and R.G. Coles, Elsevier Science, Amsterdam, pp. 101-122.

Miller, I.R., Jonker, M. and Coleman, G. 2009, *Crown-of-thorns starfish and coral surveys using the manta tow and SCUBA search techniques*, Australian Institute of Marine Science.

Moran, D., Robson, B., Gruber, R., Waterhouse, J., Logan, M., Petus, C., Howley, C., Lewis, S., James, C., Tracey, D., Mellors, J., O'Callaghan, M., Bove, U., Davidson, J., Glasson, K., Jaworski, S., Lefevre, C., Nordborg, M., Vasile, R., Zagorskis, I., Shellberg, J., 2023. Marine Monitoring Program: Annual Report for Inshore Water Quality Monitoring 2021–22. Report for the Great Barrier Reef Marine Park Authority, Great Barrier Reef Marine Park Authority, Townsville.

Muller, J.F., Mortimer, M.R., O'Brien, J., Komarova, T. and Carter, S. 2011, A cleaner river: Long term use of semipermeable membrane devices demonstrate that concentrations of selected organochlorines and PAHs in the Brisbane River estuary, Queensland have reduced substantially over the past decade, *Marine Pollution Bulletin* 63(5-12): 73-76.

Murphy, J. and Riley, J.P. 1962, A modified single solution method for the determination of phosphate in natural waters, *Analytica Chimica Acta* 27(1): 31-36.

Novoa, S., Wernand, M.R., Van der Woerd, H.J. 2013. The Forel-Ule scale revisited spectrally: preparation protocol, transmission measurements and chromaticity. *J. Eur. Opt. Soc. Rapid Public.* 8, 13057.

O'Brien, D.S., Chiswell, B. and Mueller, J.F. 2009, A novel method for the in situ calibration of flow effects on a phosphate passive sampler, *Journal of Environmental Monitoring* 11(1): 212-219.

O'Brien, D.S., Bartkow, M. and Muller, J.F. 2011, Determination of deployment specific chemical uptake rates for SDB-RPD Empore disk using a passive flow monitor (PFM), *Chemosphere* 83(9): 1290-1295.

O'Brien, D.S., Booij, K., Hawker, D.W. and Mueller, J.F. 2011, Method for the *in situ* calibration of a passive phosphate sampler in estuarine and marine waters, *Environmental Science and Technology* 45(7): 2871-2877.

O'Brien, D., Komarova, T. and Mueller, J.F. 2012, Determination of deployment specific chemical uptake rates for SPMD and PDMS using a passive flow monitor, *Marine Pollution Bulletin* 64(5).

Parsons, T.R., Maita, Y. and Lalli, C.M. 1984, *A manual of chemical and biological methods for seawater analysis*, Pergamon Press, Oxford.

Petus, C., Silva, E.T., Devlin, M., Wegner, A.S. and Álvarez-Romero, J.G. 2014a, Using MODIS data for mapping of water types within river plumes in the Great Barrier Reef, Australia: Towards the production of river plume risk maps for reef and seagrass ecosystems, *Journal of Environmental Management* 137: 163-177.

Petus, C., Collier, C., Devlin, M.J., Rasheed, M. and McKenna, S. 2014b, Using MODIS data for understanding changes in seagrass meadow health: a case study in the Great Barrier Reef (Australia), *Marine Environmental Research* 98: 68-85.

Petus, C., Devlin, M., Thompson, A., McKenzie, L., Teixeira da Silva, E., Collier, C., Tracey, D. and Martin, K. 2016, Estimating the exposure of coral reefs and seagrass meadows to land-sourced contaminants in river flood plumes of the Great Barrier Reef: validating a simple satellite risk framework with environmental data, *Remote Sensing* 8(3): 210.

Petus, C., Devlin, M., da Silva, E.T., Lewis, S., Waterhouse, J., Wenger, A., Bainbridge, Z. and Tracey, D. 2018, Defining wet season water quality target concentrations for ecosystem conservation using empirical light attenuation models: A case study in the Great Barrier Reef (Australia), *Journal of Environmental Management* 213: 451-466.

Petus, C., Waterhouse, J., Lewis, S., Vacher, M., Tracey, D. and Devlin, M. 2019, A flood of information: using the colour of the ocean and satellite imagery to monitor water quality trends in the Great Barrier Reef (Australia), *Journal of Environmental Management* 248: 109255.

Ryle, V.D., Muller, H.R. and Gentien, P. 1981, *Automated analysis of nutrients in tropical sea waters*. Australian Institute of Marine Science, Townsville.

Schäfer, R.B., Paschke, A., Vrana, B., Mueller, R. and Liess, M. 2008, Performance of the Chemcatcher® passive sampler when used to monitor 10 polar and semi-polar pesticides in 16 Central European streams, and comparison with two other sampling methods, *Water Research* 42(10): 2707-2717.

Shaw, M. and Mueller, J.F. 2005, Preliminary evaluation of the occurrence of herbicides and PAHs in the Wet Tropics region of the Great Barrier Reef, Australia, using passive samplers, *Marine Pollution Bulletin* 51(8-12): 876-881.

Skerratt, J., Mongin, M., Baird, M., Wild-Allen, K., Robson, B., Schaffelke, B., Davies, C., Richardson, A., Margvelashvili, N. and Soja-Wozniak, M. 2019, Simulated nutrient and plankton dynamics in the Great Barrier Reef (2011–2016), *Journal of Marine Systems* 192: 51-74.

Spilsbury, F.D., Warne, M.S.J. and Backhaus, T. 2020, Risk assessment of pesticide mixtures in Australian rivers discharging to the Great Barrier Reef, *Environmental Science & Technology* 54(22): 14361-14371.

Stephens, B.S., Kapernick, A.P., Eaglesham, G. and Muller, J.F. 2009, Event monitoring of herbicides with naked and membrane-covered Empore disk integrative passive sampling devices, *Marine Pollution Bulletin* 58(8): 1116-1122.

Steven, A.D., Baird, M.E., Brinkman, R., Car, N.J., Cox, S.J., Herzfeld, M., Hodge, J., Jones, E., King, E. and Margvelashvili, N. 2019, eReefs: an operational information system for managing the Great Barrier Reef, *Journal of Operational Oceanography* 12(sup2): S12-S28.

Sweatman, H., Thompson, A., Delean, S., Davidson, J. and Neale, S. 2007, *Status of near-shore reefs of the Great Barrier Reef 2004. Report to the Marine and Tropical Sciences Research Facility*, Reef and Rainforest Research Centre Limited, Cairns.

Thompson, A., Martin, K. and Logan, M. 2020, Development of the coral index, a summary of coral reef resilience as a guide for management, *Journal of Environmental Management* 271: 111038.

Traas, T.P., Van de Meent, D., Posthuma, L., Hamers, T., Kater, B.J., de Zwart, D. and Aldenberg, T. 2002, The potentially affected fraction as a measure of ecological risk. In *Species sensitivity distributions in ecotoxicology*, CRC Press, Boca Raton, FL, U.S.A. 315-344.

Uthicke, S., Thompson, A. and Schaffelke, B. 2010, Effectiveness of benthic foraminiferal and coral assemblages as water quality indicators on inshore reefs of the Great Barrier Reef, Australia, *Coral Reefs* 29: 209-225.

Valderrama, J.C. 1981, The simultaneous analysis of total nitrogen and total phosphorus in natural waters, *Marine Chemistry* 10(2): 109-122.

Van der Woerd, J.H., Wernand, R.M. 2018, Hue-angle product for low to medium spatial resolution optical satellite sensors, *Remote Sensing* 10:180.

Van der Woerd, J.H., Wernand, R.M., Peters, M., Brockmann, C. 2016, True colour analysis of natural waters with SeaWiFS, MODIS, MERIS and OLCI by SNAP, Ocean Optics conference. At Victoria BC Canada XXIII.

Vermeirssen, E.L.M., Bramaz, N., Hollender, J., Singer, H. and Escher, B.I. 2009, Passive sampling combined with ecotoxicological and chemical analysis of pharmaceuticals and biocides-evaluation of three Chemcatcher (TM) configurations, *Water Research* 43(4): 903-914.

Warne, M. S. J., Neelamraju, C., Strauss, J., Turner, R. D. R., Smith, R. A., & Mann, R. M. 2023. Estimating the aquatic risk from exposure to up to twenty-two pesticide active ingredients in waterways discharging to the Great Barrier Reef, *Science of The Total Environment* 892: 164632.

Waterhouse, J., R. Gruber, M. Logan, C. Petus, C. Howley, S. Lewis, D. Tracey, et al. 2021, *Marine Monitoring Program: Annual Report for Inshore Water Quality Monitoring 2019-20. Report for the Great Barrier Reef Marine Park Authority*. Townsville: Great Barrier Reef Marine Park Authority.

Wernand, M.R., Hommersom, A., Van der Woerd, H.J. 2012, MERIS-based ocean colour classification with the discrete Forel–Ule scale, *Ocean Science Discussions* 9: 2817–2849.

Wernand, M.R., Van der Woerd, H.J., Gieskes, W.W.C., 2013, Trends in ocean colour and chlorophyll concentration from 1889 to present, *PLoS One* 8(6): e63766.

Wheatcroft, R.A. and Borgeld, J.C. 2000, Oceanic flood layers on the northern California margin: Large-scale distribution and small-scale physical properties, *Continental Shelf Research* 20: 2163-2190.

## **Appendix A Detailed Manuals and Standard Operating Procedures**

Prepared by

Renee Gruber, Ulysse Bove, and Jack Massuger



**Australian Government**



**AUSTRALIAN INSTITUTE  
OF MARINE SCIENCE**

Australian Institute of Marine Science  
Private Mail Bag 3

TOWNSVILLE QLD 4810

<http://www.aims.gov.au/>

#### **Disclaimer**

This report has been produced for the sole use of the party who requested it. The application or use of this report and of any data or information (including results of experiments, conclusions, and recommendations) contained within it shall be at the sole risk and responsibility of that party. The AIMS does not provide any warranty or assurance as to the accuracy or suitability of the whole or any part of the report, for any particular purpose or application. Subject only to any contrary non-excludable statutory obligations neither AIMS nor its personnel will be responsible to the party requesting the report, or any other person claiming through that party, for any consequences of its use or application (whether in whole or part). The Standard Operating Procedures presented in this report are typical copies only and are updated on a regular basis. The most current controlled versions are only available through AIMS' Enterprise Content Management system for documents, in line with AIMS' Records Management Procedures. Appendices referenced in this section are not included in this report as they are internal documents only.

## Appendix A1: Operating instructions for the AIMS Sea-Bird CTD

### 1.1 Objective

To conduct vertical measurements of water temperature, salinity and other parameters throughout the water column to obtain depth profiles of water quality characteristics with a Conductivity Temperature Depth profiler (CTD) (Sea-Bird Electronics SBE19plus).

### 1.2 Materials and equipment

As currently configured, the AIMS SBE19plus' are set up to measure: Pressure (depth), temperature, conductivity (salinity), PAR (either downwelling [2π] or scalar [4π]), chlorophyll fluorescence (*in situ* fluorometer for chlorophyll *a*, WET Labs), turbidity (beam transmissometer, Sea Tech, 25cm, 660nm) and either oxygen or optical backscatter.

The Sea-Bird SBE19 CTD profiler is operated through two pieces of software, which may be downloaded from [www.seabird.com](http://www.seabird.com):

- **SeaTerm V2** – a terminal program which communicates with the CTD and controls many CTD functions, and
- **SeaSave V7** – a plotting program which displays the data.

### 1.3 Operating the CTD

#### Before you start a cast:

1. Connect the CTD to the computer: The CTD communications cable has a DB9 serial connector at the computer end.
2. At the CTD end both the CTD communications cable (4 conductor) and the bulkhead connector plug on the CTD have watertight rubber dummy plugs. Remove them and plug the communications cable into the CTD plug. Check to see that the 4 connector pins (CTD side) and the corresponding socket holes (cable side) are clean. When making a connection, **make sure the thickest pin of the CTD plug aligns with the larger hole on the CTD comms cable socket**. The bump on the outside of the comms cable socket identifies the location of the larger socket hole. When you plug the cables together, **don't force or twist the connection**. They should push together with a little 'pop'.
3. Check to see that the magnetic slider switch on the side of the CTD is in the **OFF** position (**down**). This puts the CTD in the sleep mode.

#### Communicating with the CTD:

1. Start up the computer, launch SeaTerm V2 and connect the CTD cable.
2. Click the **Instruments** menu on the SeatermV2 window and select **C. SBE 19plus V2** from the drop-down list. SeaTerm automatically connects to the instrument if the **Options** tab has **Connect at startup** enabled. The program may cycle through several baud rates if not

already configured to 9600 under **Configure** in the **Communications** menu. Once connected, the CTD prompt will appear in the main window as **S>** or **<Executed/>**. The top status bar displays Serial Port - COM1, Baud Rate 9600. Click the **CONNECT** button on the SeaTerm window. You should get a little window with a moving bar that says you are trying to connect at 9600 baud.

3. In the **Send Commands** window, click **Status** and select the **Display status and configuration parameters** command, then press the **Execute** button. Alternately type **ds** (for display status) in the main display window. The information displayed includes battery voltage, check to see that **vbatt > 12** volts. With new batteries, it should read > 13.5 volts.

### Performing a CTD cast:

1. Connect to the CTD as above and check the battery voltage is >12 volts via SeaTerm V2.
2. To clear the CTD memory prior to the cast, select **General Setup** from the **Send Commands** menu of SeaTerm V2 and select **Initialize Logging**. The **Execute** button must be clicked twice to take effect.
3. Check the depth under the keel and manoeuvre the ship so it is facing upwind and the CTD side faces the sun.
4. Connect the CTD to the hydrographic wire.
5. Unplug the communications cable and install the dummy plug and lock collar on the CTD connector.
6. Slide the magnetic switch on the side of the CTD to the **ON** position (**up**).
7. Steady the CTD by hand to stop it swinging against the boat. Lower the CTD into the water with the CTD winch so the ring at the top of the cage is two meters below the sea surface. *Some bubbles will be expelled from the tubing at the top of the CTD.*
8. Whilst keeping the CTD two meters below the top of the profile, wait **3 minutes** for the CTD to start pumping and purge the air and water out of the salinity cell, and to equilibrate the temperature of the sensors. (*The CTD has an internal pump which pumps water through the conductivity cell at a constant rate for high accuracy salinity measurements. The pump starts when the conductivity circuitry determines it is in salt water. It needs at least 30 seconds thereafter to purge the lines.*)
9. After 3 minutes, raise the CTD so the ring at the top of the cage is just at the sea surface and the PAR sensor is just under the surface, then lower the CTD to within 2-3 m of the bottom at no more than 1 m per sec. Slightly slower is preferred under calm conditions however the profiling speed should not be too slow such that heaving of the ship will cause the instrument profile to move up and down throughout the cast. [*The SBE19 samples @ 4 Hz, so a slower speed allows you to average more readings per 1 metre depth bin in the later processing step*]
10. Reel in the CTD at the same speed and retrieve to the deck.
11. Switch the CTD slider switch **OFF (down)** and secure the instrument.
12. Pull the dummy plug off the CTD bulkhead connector and re-connect the communications cable.

## 1.4 Data retrieval and management

**Retrieving the data:**

1. Electronically capture the position of the CTD cast using the Access Field Data Entry System database or record it on the field data sheets.
2. Re-establish communications with the CTD using SeaTerm V2, once the cable is connected. You should get the **S>** prompt, but if SeaTerm display window indicates 'time out' you may need to select the **Instruments** menu and click on **Disconnect and reconnect**. *If the display starts scrolling out lines of HEX characters, you've forgotten to switch the CTD off.*
3. Click the **Upload...** menu on SeaTerm V2. *The screen will display a header for the CTD cast, giving a range of metadata for the cast which is saved at the top of the uploaded file. Note the text specifying the number of samples to confirm data has been captured. A **Save As** dialog box will open, then navigate to C:\Field\CTD files\ folder to store the file. Whilst the default file name includes the serial number and date, we type in the unique station identifier as the file name.*
4. Navigate the window to the and type your desired output filename into the box. *The program will automatically append a .HEX delimiter to the filename. A small window ask which cast number you want to download. Type in "1" to download the first cast in memory. You should then get a progress window with a moving bar that counts the bytes transferred.*
5. When it's complete, the CTD file is now saved on the computer. Use Windows Explorer if you want to check that the datafile is stored in the correct location.

**Plotting the Data**

1. Launch SeaSave V7 on the computer. Normally for CTD plots, the vertical scale is depth (m).
2. Click the ArchiveData tab and then Start opens an input window that lets you select a file to plot. Navigate to your datafile using the Select Data File button in the usual Windows way and click on it to select it.
3. Click on the button at the bottom of the input box (Start Display) to plot your data using the default plot parameters stored in the computer.
4. To change the plot parameters, use the ScreenDisplay tab to select "Edit Selected Display Window". This will allow you to load another plot parameter file (.dso) that might be more appropriate to your data set, to directly modify the plot you already have or save the plot parameters for future use. There are a number of .dso files on the pathway in the box. The plotname usually gives the depth range.
5. If you select to Modify Display Parameters, you will get a menu to change the output style. The Y axis is normally depth on the CTD computer. The Select Variable button puts you in a small window that lets you select the variable (from a particular instrument type) that you want to plot.
6. Save the plot as a .dso file if you want to shut down the laptop and use it again later. After you click "OK" to close the above window, you will be in the previous dialog which lets you save the parameters in a .dso file. Exit that box and you will be looking at a changed, but blank plot.
7. To replot the data, select the ArchiveData tab and Start, check the input filename in the next dialog box and click the Start Display button again to see the plot. If you are not happy, go back to step 4 and try again.
8. Save all data on the hard drive and the backup external hard drive. Immediately upon return to AIMS transfer all data to the MMP shared file area on the AIMS Server.

## 1.5 Maintenance

After the CTD profiles are completed:

1. Disconnect the CTD from the communications cable and reattach the dummy plugs on both ends.
2. Wash the CTD thoroughly with fresh water.

## 1.6 Quality control

- When on board RV Cape Ferguson, CTD cast data are immediately plotted and checked so the cast can be repeated if there were erroneous readings or other technical problems.
- The CTD sensors are regularly sent to either the manufacturer or CSIRO Oceans and Atmosphere Oceanographic Calibration Facility for calibration (generally annually).
- Salinity and chlorophyll readings from CTD sensors are validated against results from direct water sampling using Niskin bottles conducted immediately after the CTD cast.
- Temperature readings from CTD sensors are validated against temperature readings from high quality reversing thermometers attached to the surface and bottom Niskin bottles.

## Appendix A2: Measuring salinity using the Portasal Salinometer 8410A

AIMS-SOP-(EFWQ)-v1.0

### Document Details

<b>Implementation date:</b>	15/05/2021	<b>Authorised by:</b>	Ulysse Bove
<b>Edition No:</b>	3.0	<b>Responsible Officer:</b>	Ulysse Bove
<b>Date of Issue:</b>	15/05/2021	<b>Review date:</b>	29/04/2024

### TASKS INCLUDED IN THIS SOP

This method outlines the operational and calibration procedures for measuring salinity using a Portasal Salinometer model 8410A.

### PRINCIPLE AND RESPONSIBILITIES

Laboratory measurements of salinity with a Portasal Salinometer are based on a high-precision comparison of the conductivity of an unknown water sample with the conductivity of a well-characterised sample of sample of IAPSO (International Association of Physical Science Organisations) Standard Seawater (IAPSOSW). “The conductivity of seawater is proportional to the salinity. With the appropriate corrections for temperature and pressure, the measurement of conductivity has become the most generally used method of determining salinity. Electrical conductivity is a measure of total electrolyte concentration in seawater, and it is a technique which can be performed rapidly and with great accuracy, both in laboratories and in situ. (Devlin and Lourey, 2000).

The reliability and accuracy of salinity analyses by conductivity are best if the unknown samples have a salinity that is reasonably close to that of the standard. While estuarine samples can readily be run, conductivity comparisons with very low salinity samples are progressively less reliable. In most cases, samples with salinities > 25-30 ‰ should be suitable. Low salinity “standards” can be made by precise dilution of standard seawater. In low salinity estuarine samples, the use of conductivity is confounded by the potentially differing ratios of ions in the “fresh” water which may have a different conductivity-mass relationship from seawater.

**SIGNIFICANT HEALTH & SAFETY RISKS**

<b>Hazards</b>	<b>Risk</b>	<b>Control</b>
Manual handling	Biomechanical	Reduced combined weight of samples. Use proper lifting techniques. Use trolley to move
Ergonomic	Static posture	During salinity measurement session take regular break, change position, or alternate staff carrying the measurements to avoid elongated static
Electrical	Electrical shock	Protect electronic components from water leaks/spills and clean up any spills immediately. Disconnect instrument before conducting maintenance or servicing. Call an electrician if you

**PERSONNEL PREREQUISITES & COMPETENCIES**

**Laboratory safety induction**

**Read and understood procedure**

**Training by experienced technician**

**TOOLS & EQUIPMENT**

- 250 mL screw cap polyethylene bottles – RO water rinsed and air-dried
- Primary standard seawater IAPSO P-series from OSIL (IAPSOSW) at room temperature – 1 x 250 mL bottle
- Secondary standard seawater (SSW) from Coral Sea around 34 to 36 PSU at room temperature as a secondary standard – 1 L to 2 L
- Milli-Q water at room temperature, approx. 500 mL
- Kimwipes
- Drain bucket and salinometer drain tubing.

- Laptop with OSIL salinity data logger installed.
- RS232 cable and USB to RS232 adapter
- Guideline Portasal Salinometer

## ENVIRONMENTAL CONSIDERATION

None as no reagents or preservatives are used during the measurement calibration or process.

## CHEMICAL DISPOSAL

No chemicals are used the processing of samples.

## REFERENCES

- Guildline Instruments (2001). Manual for Guildline Model 8410A Portable Salinometer.
- Devlin, M.J. and Lourey, M.J. (2000). Long term Monitoring of the Great Barrier Reef Standard Operational Procedure Number 6, Australian Institute of Marine Science.
- Guildline Instrument technical manual for model 8410A Portasal, TM841A-J-00, May 2006

## PROCEDURE

### 1. SAMPLE COLLECTION AND STORAGE

- Water samples for laboratory salinity analysis are normally drawn from one to two Niskin bottles at each hydro station. The salinity sample is usually taken last from the Niskin bottle as gas exchange or contamination are not issues. Salinity samples should be taken from bottles tripped near the top

and bottom of the water column to get the maximum range of salinities measured at a station.

- Salinity samples are stored in 250 mL screw-capped plastic bottles. Before a cruise, the bottles are soaked in RO water and air dried to remove old salt crystals. Before taking a sample from the Niskin Bottle, rinse the sample bottle and cap with sample water. Fill the bottle to near the top, leaving only a small air bubble (<20 mL) in the bottle to minimize evaporation. Put the cap on tightly. Store in a cool room (4-5°C), if possible, or at air-conditioned room temperature. Do not expose to full sunlight or excessive heat. Do not freeze.
- Sub-standard sea water for secondary standards (SSW) is normally pumped into 40 L plastic drums at convenient times when an AIMS vessel is operating outside the reef. With the deck hose running, rinse out the drum thoroughly, then pump at least 30 L into the drum. Screw the lid on fully and store against the rail. At the lab, the seawater is stored in a walk-in cold room (5°C). Several days before use, some of the water should be transferred to a 1L to 5 L aliquot bottle/carboy in the salinity measurement room. The carboy is fitted with a siphon to remove water without bubbles. The secondary water should be allowed to fully equilibrate to room temperature before use.

## **2. SALINOMETER SET UP AND CALIBRATION**



### **a. Preliminary to using salinometer**

- Bring the salinity samples out of the cold room 48 hours before analysis and put them in the laboratory where the salinometer to fully equilibrate to room temperature. Ideally the room temperature should be approximately 23°C.
- The temperature of the bath water should be set to about 2°C above ambient room temperature. See section .b to change bath temperature. Get a new sealed 250ml bottle of IAPSO standard seawater (IAPSOSW) and a 1L to 2L bottle of Sub-standard sea water (SSW) let both equilibrate next to the salinometer as well.
- Make sure you have enough (>1 L) secondary standard seawater (SSW) in a full dedicated plastic bottle to allow for several (5 to 10) drift correction measurement during your salinity measurements. If you need more, put it in at least the night before to allow temperatures to equilibrate.
- Make sure the drain tubing is put in an empty bucket to collect waste sample water. As the bucket fill make sure the drain tubing does get submersed under the wastewater to avoid back pressure issue in the

sample water fill/drain system and consequently in salinity measurement cell.

- Before turning the salinometer power make sure the FUNCTION switch is in the STDBY position, and the peristaltic pump speed selector is on 0.
- Before proceeding, please note that the external peristaltic pump is an after-factory modification and is not shown in the factory manual. To operate this pump requires its own power outlet and it has four speed setting (0, 1 2 and 3). Normally the lowest speed (1) will be sufficient for regular measurements and the higher speed settings (2 and 3) are used for flushing the conductivity cell at the end of salinity measurement session. Always leave the FLOW RATE switch on the salinometer in the “ON” position during use although its only function since the installation of the peristaltic pump is to keep the venting line open (Appendix 1).
- Ideally samples to be measured should be 2°C below the bath temperature. In extreme cases, samples up to 15°C below the bath temperature or 5°C above the bath temperature can be measured if the flow rate is reduced sufficiently to allow the sample to reach the bath temperature while in the heat exchanger, however this practice may not give the most accurate results obtainable.
- Ensure the salinometer is communicating with the associated laptop and salinity logger by opening the software and starting a new run that will be discarded (see below). This will ensure that you can both standardize the salinometer and record the value of the IAPSOSW using only one primary standard sea water.

#### **b. Salinometer set up**

- Power the salinometer and attached peristaltic pump by turning ON the 2 power outlet next to the salinometer the salinometer unit as well as the main power switch located at the back of the salinometer instrument
- Set the salinometer water bath to the required temperature (approx. 2°C above room temperature) by:
  - Pressing the “T-Set” key on the salinometer keypad
  - Increment or decrement the displayed valued on the salinometer screen using the  or  on the keypad until the required temperature is displayed (each arrow button press increment or decrement by 1°C)
  - Press “ENTER”
  - Water bath should be left approx. 1.5 hours to reach a stable and desired set temperature  $\pm 0.02^{\circ}\text{C}$  at which time a salinity standardization can be undertaken

- Water bath temperature can be check at any time by pressing the TEMP key on the salinometer keypad.

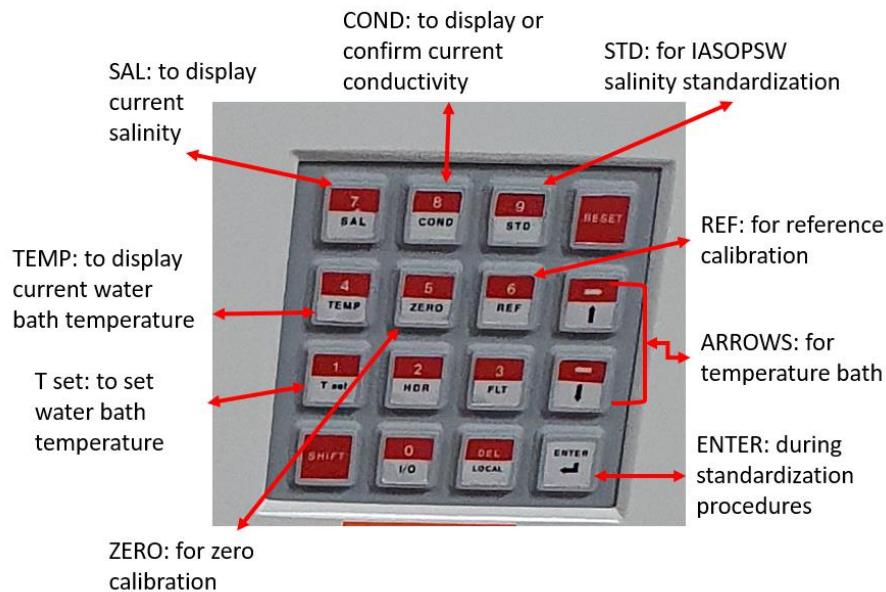

- Perform a flow rate check by:
  - Placing the intake pipe in the SSW water bottle
  - Turning the FLOW RATE switch on "OPEN" on salinometer
  - Ensuring the FUNCTION switch is set to STDBY
  - Turning the peristaltic pump speed to 1
  - Filling the conductivity cell, ensuring all four arms of the conductivity cell fill sufficiently to cover electrodes
  - Covering the FLUSH vent momentarily with fingertip to allow the water to empty from the cell and then allow to refill
  - Repeat this process 3 times
  - Turn peristaltic pump off and FLOW rate to OFF to keep the salinity cell filled with SSW while the salinometer water bath reaches the required temperature.
- This step ensures a reduction of observed salinity drift when the salinometer has not been used for a couple of days and the conductivity cell has been left dry, in Milli-Q, or has gone through a cleaning procedure.
- If air bubbles are adhering to the cell and are hard to dislodge by flushing, it may be necessary to clean the cell as per the instructions in Appendix 1.
- Each time the Portasal has been powered up or the bath temperature has been changed, allow 1.5 hours with the bath temperature regulating at 2°C above

ambient before standardising or calibrating. A timer switch is available that can be utilised to turn the machine on outside of work hours so that it is ready for use at a predetermined time. If the temperature will not stabilise, do not use the machine and perform a temperature check as well as a bath temperature check (see Appendix 1)

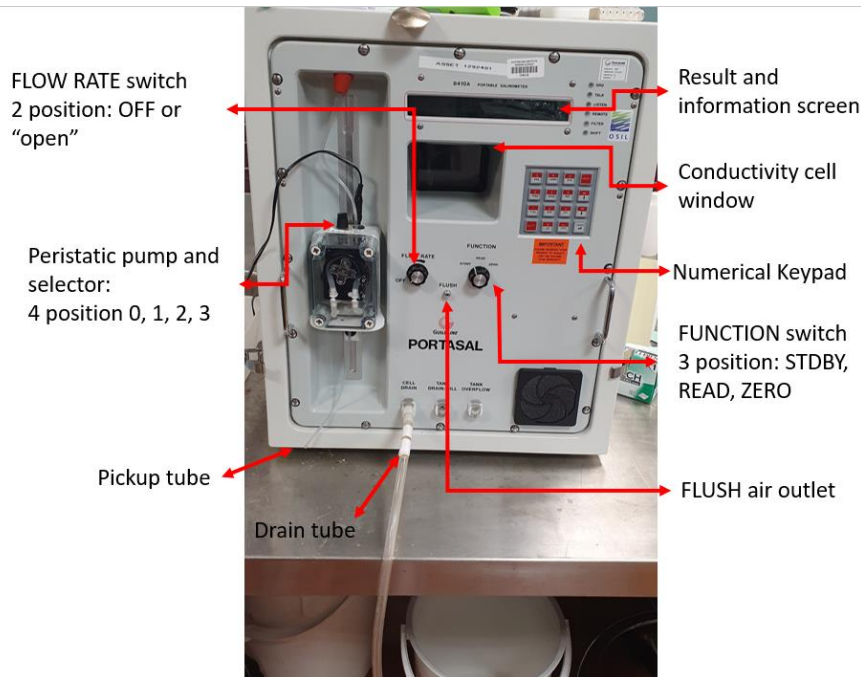

### c. Salinometer to salinity logger software check

- Perform a software to salinometer communication check and salinity data acquisition set up:
  - Ensure salinometer RS232 is plugged at the back of the instrument and is connected to the laptop USB to RS232 adapter.
  - On the laptop go to “device manager” and in “ports” sub menu check which COM port is connected (eg:COM4)
  - Start the OSIL salinometer data logger on the computer and in the “settings” sub menu select “communications”

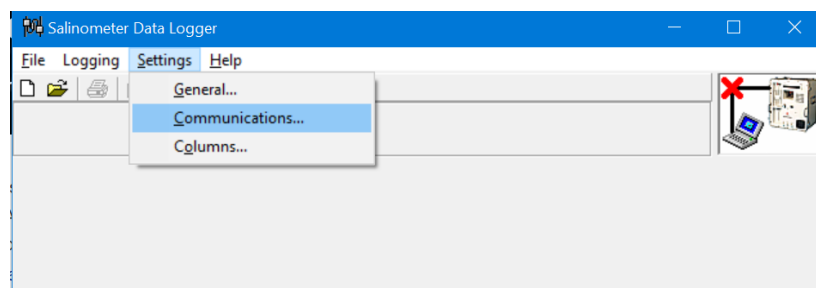

- In the communication windows select Portasal 8410 as a device and enter the COM port number identified previously un the “port number” window (eg:4).

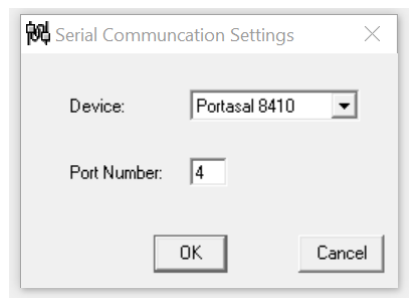

- Press “OK”
- Go to “File” then “New”, a window called “Set up salinometer” will appear, press “Continue”

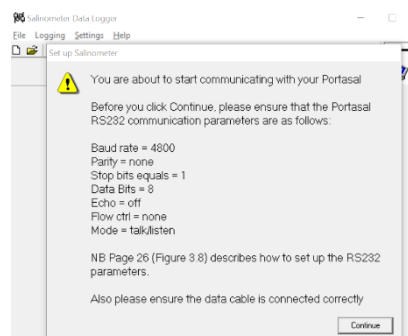

- The salinometer and logger software should start communicating and a new logger sheet menu should be created.
- Cancel the creation of the new logger sheet before starting the salinity standardization process (If the communication is not established, re-check the COM port number in the “device manager” and repeat communication protocol.)
- Prior to start any salinity measurement, in the OSIL logger software, go to “settings” then “general”.

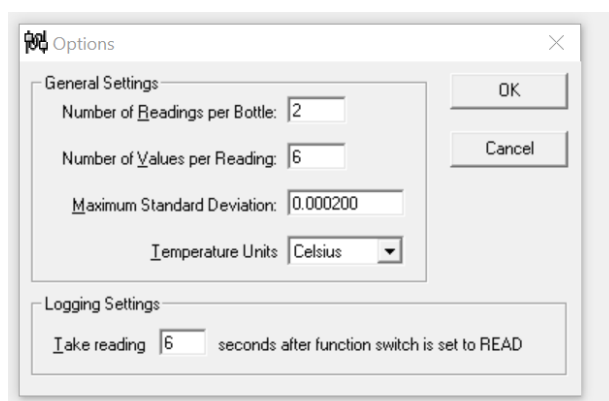

- In the “option” windows set the followings

- Number of readings per bottle: 2
- Number of values per readings: 6
- Maximum standard deviation: 0.0002
- Temperature unit: Celsius
- Take reading “6” seconds after function switch is set to read.
- Press “OK” to set data acquisition values for the subsequent salinity measurements.

#### **d. Standardization**

The Portasal is usually quite stable but to ensure quality control, a salinity standardization routine should be performed using a new sealed IAPSOSW bottle every time the instrument is powered up, the bath temperature is changed, or a set of salinity sample measurements are taken.

To perform the Standardization and drift Correction Routines the instrument needs to be powered up for a minimum of 1.5 hours and the displayed temperature be stable  $\pm 0.02^{\circ}\text{C}$  to the previously set up temperature.

The salinometer standardization is independent of any data acquisition by the OSIL salinometer software and should be carried out without the software logging any values (except in the last step of the standardization process when the IAPSOSW standard value is checked and logged).

Using a new sealed bottle of Standard Sea Water (IAPSOSW) as the primary standard, fill and flush 3 times and fill the cell similarly to what is described in the Sample Measurement procedure (below) steps 1 through 15.

- Rocking the IAPSOSW bottle gently to eliminate gradients without creating air bubbles
- Ensure the FUNCTION switch is set to STDBY
- Turn the FLOW RATE switch on open on the salinometer
- Turn the peristaltic pump speed to 1
- Wipe the intake tube using a Kimwipe
- Place the intake tube in the IAPSOSW standard bottle (use Kimwipe to handle the intake tube)
- Filling and flushing the conductivity cell 3 times ensure all four arms of the conductivity cell fill sufficiently to cover electrodes. Cover FLUSH vent momentarily with fingertip to allow the water to empty from the cell and then allow to refill
- When cell has been filled for the third time, Turn the FUNCTION switch to READ

- Press STD on the salinometer keypad. (Please Note: Once the following procedure has commenced do not flush the cell and do not move the FUNCTION switch from READ)
- The following prompt will be displayed:
  - STD STANDARDIZE
  - Press ENTER key
- You will then be prompted with:
  - COND NO 0.99984 (example value only)
  - Enter the correct conductivity ratio as shown on the label of the IAPSOSW bottle
  - Press ENTER key
- You will then be prompted with:
  - BATCH NO P113 (example value only)
  - Enter the correct batch number as shown on the label of the IAPSOSW bottle
  - Press ENTER key
- You will then be prompted with:
  - ENTER WHEN READY
  - Ensure the conductivity cell is full and free of bubbles
  - press ENTER key
- “Measuring...” will briefly appear on the display followed by:
  - STANDARD 4.22000 (example value only)
  - When satisfied that the displayed number is stable (approx. for 10s), press ENTER key. This will terminate the standardisation operation and display the conductivity ratio using the new calibration values.
- Turn the FUNCTION switch to STDBY
- Start a new salinity log sheet on the OSIL salinity data logger as described in salinometer to logger software check section (ensure acquisition conditions are

properly set) and fill the relevant information on the log sheet (mostly file name, technician and room temperature)

- When a new salinity log sheet is created on the OSIL software, computer will prompt the user to turn the FUNCTION switch to ZERO (approx. 5s). Please make note of this value (usually  $0.00000 \pm 0.00005$ ) as zero reading will be required at the end of a salinity log sheet session.
- Turn the FUNCTION switch to STDBY as prompted by the software.
- Flush and refill the cell one time
- Turn the FUNCTION switch to read
- Following onscreen direction operate the FUNCTION switch from STDBY to READ two times for acquisition of 2 averaged salinity values from 6 readings each.

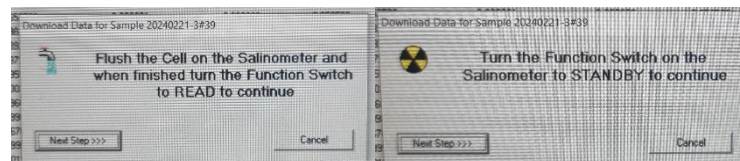

- Once the measurement is taken and CV value of repeated reading and average values is satisfied the software will prompt you to re-take a measurement from this bottle.
- Press "NO"

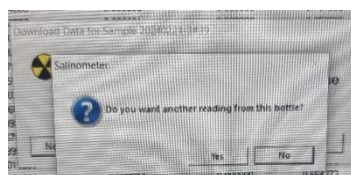

- Once the salinity acquisition is completed, confirm that the measured average salinity value acquired on the computer correspond to the IAPSOSW salinity value written on the bottle  $\pm 0.001$ PSU.
- On the computer log sheet, right click on the bottle#1 on the log sheet list and press "enter bottle label", then enter the name "IAPSOSW" for this sample

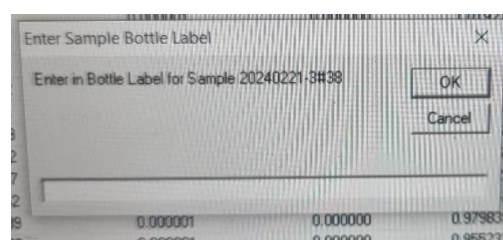

- Remove the IAPSOSW bottle from holder, flush the salinometer cell and wipe the intake tube with a Kimwipe
- If the 1<sup>st</sup> salinity measurement correspond to the IAPSOSW bottle value, the salinity standardization is successful and you can continue with the 1<sup>st</sup> drift correction routine measurement and subsequent samples measurements.
- If the standardization is unsuccessful, please repeat the standardization protocol using a new IAPSOSW bottle until successful.

#### **e. Drift Correction Routine**

- To minimise the use of expensive commercial primary standard (IAPSOSW), a secondary standard (SSW) is used. This is just clean seawater (preferably collected off the continental shelf to ensure maximum clarity). This samples are run similarly to a regular salinity sample as described in the Sample Measurement section. The SSW value is acquired directly after the IAPSOSW salinity confirmation, every 20 samples thereafter and as the last sample measured in a given session preferably at samples position #2, 23, 44, 65, 86, 107, 128.etc on the salinity log sheets for the automated excel drift analysis. A quick reference guide to this procedure listing just the necessary keystrokes can be found in Appendix 2. A drift calculation is then applied to the sample readings assuming linear drift between the two substandard readings (see Appendix 3).

### **3. SAMPLE MEASUREMENTS**

- 1) Rock sample bottle gently to eliminate gradients. Do not introduce air bubbles by shaking it.
- 2) Wipe salinometer pickup tube using a Kimwipe
- 3) Insert the intake tube in a sample bottle using a Kimwipe. Ensure that the pick-up tube reaches almost to bottom of bottle such that flow will not be restricted. Care must be exercised not to contaminate the sample. Do not handle the pickup tube except with clean lint-free tissue for wiping or surgical gloves for handling. Do not pump the sample through too fast or its temperature will not equilibrate with that of the water bath before reaching the cell and readings will be erratic.
- 4) Fill and then empty the cell by placing fingertip over FLUSH air vent. Be sure to completely fill the conductivity cell and that are no air bubbles are present
- 5) Fill and flush again
- 6) Fill the cell again and ensure no air bubbles are present in the conductivity cell, especially along the four electrode along the length of the conductivity cell.
- 7) Turn the FUNCTION switch to READ

- 8) Following the onscreen direction operate the FUNCTION switch from STDBY to READ two times for acquisition of 2 averaged salinity values from 6 readings each.

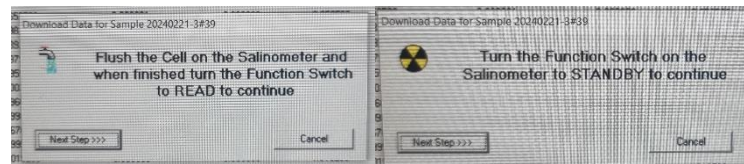

- 9) Once the measurement is taken and CV value of repeated reading and average values is satisfied the software will prompt you to re-take a measurement from this bottle.

- 10) Press "NO"

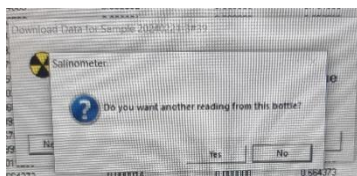

If the CV value conditions are not satisfied the following window will appear

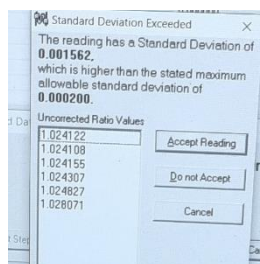

In such case press "Do not Accept" and then press "YES" when prompted to take another reading from the bottle and repeat step 4) to 10)

- 11) On the computer log sheet select the last sample acquired by the software, right click on the bottle number and press "enter bottle label", then enter the name written on the bottle label for this sample (If the sample measured is the secondary standard enter "SSW")
- 12) Remove the intake tube from the sample bottle
- 13) Flush the cell
- 14) Wipe the intake tube using a Kimwipe
- 15) Repeat the protocol for the following sample bottle to be measured from step .1)
- 16) At the end of a salinity measurement session, export the acquired results into an excel spreadsheet by pressing "X" symbol in the salinometer logger software.

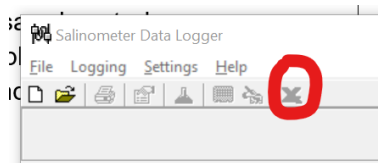

On the following export windows select to export data as “sample and Readings data only. Save and name the exported excel file “SAL\_YYYYMMDD” and place it in the relevant folder for drift correction analysis

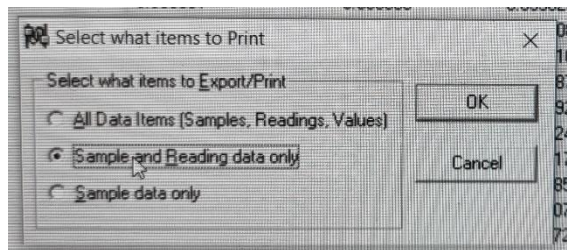

- 17) When closing the salinity log sheet, the computer will prompt you to acquire a final zero value by turning the FUNCTION switch to “ZERO” similarly to when the log sheet was created. This value should be close to  $0.00000 \pm 0.00005$  and similar to the value measured initially. If this value differs, please inform laboratory manager or trained technician for re-calibration.

#### 4. STANDBY OR SHUTTING DOWN:

- If another sample is not to be measured immediately, leave the pickup tube sample bottle in the sample bottle holder with the conductivity cell filled, set FUNCTION switch to STDBY, turn the peristaltic pump on the “0” position and turn off the FLOW rate.
- If another sample will not be measured for at least 12 hours, set FUNCTION switch to STDBY, remove the sample bottle, install a bottle of Milli-Q water, turn the peristaltic pump to the “3” position, fill and flush the conductivity cell at least 5 times using Milli-Q water then empty it and store empty to avoid algal growth. Turn off the salinometer and peristaltic pump by turning the power outlet to off.

#### 5. DATA MANAGEMENT:

The sample readings are logged by the salinity software during measurements and then exported as a Microsoft Excel spreadsheet. Average salinity values for each samples are then exported into a template called "SAL\_dritcorr.xls" which will automatically perform all salinity drift measurement calculation according to the first and subsequent SSW values measured in a given salinity measurement session (Appendix 4).

## 6. QUALITY CONTROL

QA/QC tests undertaken as part of the data reporting include:

### Assessment of accuracy of the analysis

This is generally achieved by using reference materials to assess recovery of known amount of analyte.

- The certified reference material available is IAPSO P-series Standard Seawater ([www.osil.co.uk](http://www.osil.co.uk)), which is included at regular intervals during the analysis.
- If during the standardization the salinity from the IAPSOSW returns a value drifting by  $\pm 0.001$  PSU, the standardization is repeated until the standardization reaches the expected IAPSOSW standard.
- If during the analysis the conductivity from the SSW returns a value drifting by  $\pm 0.0005$ , the samples measurements are stopped and repeated after instrument re-calibration.

#### a. Assessment of precision of the analysis

*NB: This is generally achieved by the repeated analyses of the same concentration of analyte to check for reproducibility.*

- Repeated analysis of IAPSO (IAPSOSW) and SSW
- Using the SSW the standard deviation of all samples taken within a daily session is usually  $\pm 0.003$  PSU.

## APPENDICES

*All appendixes must be referenced within the body of the SOP*

#.1	Portasal operation and maintenance
#.2	Quick guide to standardization and sample measurement
#.3	Sample analysis worksheet
#.4	Salinity Portasal calculation sheet
#.	

## RECORDS

All AIMS analyses undertaken on behalf of AIMS or a client must be recorded and stored as follows:

- Data must be lodged in a manner that complies with External Document and Data Control Policy, Data Access Policy and AIMS Disaster Recovery Plan, and must have an associated metadata record (see the Data Access Policy for full details).
- Raw experimental measurement data must be stored as hard copy and digitally as specified by the External Document and Data Control Policy, and data from processing samples must be stored in the Data Centre with appropriate metadata (see this policy for other approved storage locations and requirements).
- The data custodian(s) is/are responsible for lodging the data and generating the metadata record.

---

## Appendix A3: Automated analysis of dissolved nutrients in seawater

### 3.1 Objective

Analyses of concentrations of ammonia ( $\text{NH}_3$ ), nitrite ( $\text{NO}_2$ ), nitrate ( $\text{NO}_3$ ), phosphate ( $\text{PO}_4$ ), silicate ( $\text{Si}(\text{OH})_4$ ), total dissolved nitrogen (TDN), and total dissolved phosphorus (TDP) in water samples, with a focus on detecting very low concentrations of nutrients ( $< 0.1 \mu\text{mol L}^{-1}$ ) with a high levels of precision.

### 3.2 Principle of analysis

Inorganic dissolved nutrient concentrations are determined by standard wet chemical methods (e.g. Parsons et al. 1984) with spectrophotometric detection based on Ryle et al. (1981) and Bran and Luebbe (1997), implemented on a Seal AA3 Analyser segmented flow analyser.

### 3.3 Sample analysis

#### 3.3.1 Materials and Equipment

A nutrient analytical section is established at AIMS in a dedicated laboratory to undertake low-level nutrient analysis where all laboratory ware and equipment are used for that sole purpose to assist in avoiding contamination.

1. Continuous segmented flow autoanalyzer (SEAL AA3 Analyser and its accompanying software, (SEAL AACE Software Version 7.06).
2. Laboratory facilities and labware:
  - Lab air intakes in location likely to be minimally affected by atmospheric contaminants.
  - Sample storage in dedicated, clean, locked and alarmed freezers. The freezers are on power circuits with UPS/generator backup and are checked regularly by security personnel. Initially, racks of samples to be analysed are stored in a holding freezer. When the samples are logged into the laboratory data system, they are transferred to a pre-analysis freezer, where they are tracked by rack number.
  - Weighing balances (serviced/calibrated annually).
  - Volumetric flasks and positive displacement pipettes for preparation of standard solutions.
  - Cleaned, plastic ware is used where possible to avoid contamination from dissolution of silicate.
  - All glass and plastic ware is washed with 10% HCl and rinsed with 18M $\Omega$  water; other equipment is rinsed with 18M $\Omega$  water.
3. Reagents and Water
  - Nutrient standards are prepared using AR grade chemicals, wherever possible [( $\text{NH}_4$ )<sub>2</sub>SO<sub>4</sub>, KNO<sub>3</sub>, NaNO<sub>2</sub>, KH<sub>2</sub>PO<sub>4</sub>, NaSiO<sub>3</sub> · 9H<sub>2</sub>O].
  - Analytical reagents are prepared with AR grade chemicals wherever possible.
  - Water is 18M $\Omega$  quality.

### 3.3.2 Method

#### 3.3.2.1 Samples

- Samples are received and stored frozen in dedicated freezers. Before analysis, samples are thawed overnight in 4°C refrigerator, then uncapped, placed in sample racks and covered with alfoil for analysis.
- Samples for analyses of total dissolved nitrogen and phosphorus are oxidised with persulfate reagent under alkaline conditions before analyses are carried out (Attachment 3.1).

#### 3.3.2.2 Standards

- Primary stock standards are prepared in 18MΩ water and stored for up to 6 months at 4°C.
- Six working standards are prepared fresh from stock standards prior to each analysis run.
- Working standards are prepared over the following (low/high) ranges are:
- Working standards are prepared over the following ranges are: NH<sub>3</sub>: 0-10 µmol-N L<sup>-1</sup>; NO<sub>3</sub>: 0-30 µmol-N L<sup>-1</sup>; NO<sub>2</sub>: 0-3 µmol-N L<sup>-1</sup>; PO<sub>4</sub>: 0-3 µmol-P L<sup>-1</sup>; Si: 0-30 µmol-Si L<sup>-1</sup>.
- Working standards are prepared in a matrix which matches the refractive index of samples (e.g. fresh, estuarine or marine waters) by addition of appropriate amounts of AR grade NaCl to DIW.
- Certified reference standards for each nutrient analysis are purchased from Oceans Scientific International and Research Council of Canada (NRC) and prepared as a mixed standard to fit within the working concentration range of the samples being analysed
- In-house sea water storage reference samples:  
Coastal seawater obtained from the AIMS pontoon is filtered through 0.45 µM cellulose acetate filters. The final filtered volume (approx. 4 L) is spiked with stock standards to read within working concentration range (e.g. NH<sub>3</sub>: 2.4 µmol L<sup>-1</sup>, PO<sub>4</sub>: 1.7 µmol L<sup>-1</sup>, NO<sub>2</sub>: 0.7 µmol L<sup>-1</sup>, NO<sub>3</sub>+NO<sub>2</sub>: 2.3 µmol L<sup>-1</sup>, Si: 9 µmol L<sup>-1</sup>), dispensed into 10ml plastic sample tubes and frozen. Aliquots of a batch of these reference samples usually last for several years and are prepared as required.

#### 3.3.2.3 Calibration

- Pipettes are gravimetrically calibrated before use.
- The auto-analyser is calibrated for each analysis (nutrient species) with mixed working standards. The working standards are utilised for each run to establish a standard curve from which the sample concentrations are calculated.
- The linear response of the working ranges utilises a 1<sup>st</sup> order linear regression fit, calculated as  
  
part of the auto-analyser software package.
- Each tray protocol as part of every analysis session consists of:
  - Six working standards for a linear calibration curve.
  - QA/QC standards: replicate in-house seawater storage reference samples and certified reference standards.
  - Blank samples for drift and baseline corrections (part of the autoanalyzer software) are included at regular intervals within the sample set (maximum up to 60 samples per interval).

### 3.3.3 Calculations

- Instrument charts are checked and edited upon completion of a run to ensure signals are correctly detected. Editing is performed within the standard auto-analyser software by moving the peak markers to the top of the sample peak. The auto-analyser software is used for the initial processing which include:
- Standard-curve fit, drift correction, base calibration, calculation of sample concentrations.
- Further processing is carried out using Excel functions in a spreadsheet: e.g. Data is standardised against reference standards and corrected for any dilution factors.
- If there are problems with the chart output, (excessive noise, power outages, hardware problems, software problems) sample peaks are hand measured using digital Vernier callipers and a 1st order regression calibration is performed in an Excel spreadsheet.

### 3.4 Instrument performance

The method for determination of method detection limits (mdl) is that adopted by Bran and Luebbe from the US Environmental Protection Agency (Bran & Luebbe 1997). Given the variability inherent in environmental samples and that conditions for each automated run are never absolutely identical, detection limits are calculated for each run. Detection limits are statistically derived from multiples of the standard deviation of the baseline readings. Increased gain with acceptable baseline noise (at lower concentration ranges) yielded detection limits of  $0.02 \mu\text{mol L}^{-1} \text{NH}_3$  (0-4  $\mu\text{mol L}^{-1}$ ),  $0.01 \mu\text{mol L}^{-1} \text{PO}_4$  (0-2  $\mu\text{mol L}^{-1}$ ),  $0.03 \mu\text{mol L}^{-1} \text{NO}_2+\text{NO}_3$  (0-4  $\mu\text{mol L}^{-1}$ ),  $0.01 \mu\text{mol L}^{-1} \text{NO}_2$  (0-2  $\mu\text{mol L}^{-1}$ ),  $0.10 \mu\text{mol L}^{-1} \text{Si}$  (0-20  $\mu\text{mol L}^{-1}$ ).

### 3.5 Data management

Unique sample identifiers for all samples are supplied by staff requesting analyses. These are provided electronically as an Excel spreadsheet linked to the request form. Sample IDs are transferred to Analytical Technology datasheets (Excel). A unique Job Number is assigned to each analytical request, under which all information associated with the analyses is filed. Spreadsheets with the nutrient data results are sent to staff requesting analyses (example of client report in Attachment 3.2). All nutrient data results incl. QA/QC data are archived by the analytical section as Excel spreadsheets. For more details about AIMS Data Management procedures for Reef Rescue MMP refer to Section A12.

### 3.6 Quality control

QAQC tests undertaken and reporting as part of the data reporting include:

#### Assessment of the limit of detection (LOD)

*NB: the Limit of Detection (LOD) or detection limit, is the lowest concentration level that can be*

*determined to be statistically different from a blank (99% confidence).*

- Detection limits are reported for each analytical batch and are statistically derived from

multiples of the standard deviation of the baseline readings, which are conducted during analysis.

#### Assessment of accuracy of the analysis

*NB: This is generally achieved by using reference materials to assess recovery of known amount of analyte.*

- External certified reference standards are measured at regular intervals during analysis.
- Regular validation of the analyses by continued participation in inter-laboratory trials, e.g. biannually with Quasimeme (<http://www.quasimeme.marlab.ac.uk/about.htm>) and annually with the national low-level nutrient collaborative trials (NLLNCT, Australia).
- As a further measure to ensure analytical accuracy, spikes of known concentration were added to natural seawater samples on board of the research vessel, during the normal sample preparation and analysed as part of the sample batch, unbeknown to the analyst

#### Assessment of precision of the analysis

NB: This is generally achieved by the repeated analyses of the same concentration of analyte to check for reproducibility.

- Recording of in-house seawater storage reference samples for each nutrient species analysed.

#### Procedural blanks:

- Blank samples for drift and baseline corrections (part of the autoanalyzer software) are included at regular intervals within the sample set (maximum up to 60 samples per interval)

#### Reproducibility of duplicate analytical units

*NB: The variation between results for sample duplicates indicates the reproducibility of the analysis and also the effects of various sources of contamination and analytical error during collection, sample preparation and analyses. Before data analysis, results are generally averaged over duplicates.*

- Coefficients of variance are calculated from analytical results of sample duplicates. Duplicates with CV>30% are discarded from the analysis and the analysis repeated using extra duplicates that are generally collected as a backup.

#### Other

- Spike recovery: As a further measure to ensure analytical accuracy, spikes of known concentration were added to natural seawater samples on board of the research vessel, during the normal sample preparation and analysed as part of the sample batch, unbeknown to the analyst.

### **3.7 References**

Bran and Luebbe (1997) Directory of Autoanalyser Methods, Bran and Luebbe GmbH, Norderstedt, Germany.

Parsons, T.R., Yoshiaki, M. and Lalli, C.M. (1984) A manual of chemical and biological methods for seawater analysis, Pergamon, London. pp22-25.

Ryle VD, Mueller HR, Gentien P (1981) Automated analysis of nutrients in tropical sea waters. AIMS Technical Bulletin, Oceanography Series No. 3, Australian Institute of Marine Science, Townsville. P. 24.

---

**Attachment 3.1 Persulfate digestion for analysis of total dissolved nutrients****Principle**

Significant pools of N and P are complexed within dissolved organic matter or organisms. To measure of the total amount of N and P within a sample, it is necessary to decompose these N and P pools to a form that can be quantified. This decomposition can be achieved by exposure of samples to an oxidising reagent with the speed to completion of the oxidation reaction being promoted by exposure to heat and pressure via an autoclave. Persulfate oxidation under alkaline conditions results in conversion to nitrate which can then be converted to nitrite for colorimetric quantitation in the Bran+Luebbe AutoAnalyzer III.

**Hardware**

- 1) Harvey SterileMax Autoclave (Barnstead, USA) with attached printer located in West First Photo- oxidiser Room
- 2) Sarstedt vials (Cat # 60.9922.210)
- 3) Sarstedt lids (Cat # 65.9923.335)

**Reagents**

- 1) Potassium peroxodisulfate ( $K_2S_2O_8$ ) - use the highest quality reagent with low N and P
- 2) Sodium hydroxide (NaOH) - use the highest quality reagent with low N and P
- 3) Boric Acid ( $H_3BO_3$ ) - use the highest quality reagent with low N and P
- 4) Persulfate oxidising solution: mix 7.5 g of NaOH and 25 g of  $K_2S_2O_8$  and 15 g  $H_3BO_3$  in 400 mL of reagent grade water. Stir until all reagents are dissolved. Make volume to 500mL. Make fresh daily.

**Procedure**

- 1) If samples are frozen, thaw samples by running under a continuous flow of cold water
- 2) Make up test samples, calibration standards, In-House Reference Materials and Certified Reference Materials
- 3) Thoroughly mix samples and then decant 10 mL into a Sarstedt vial. If samples contain high amounts of particulates dilution series should be carried out at this point
- 4) Add 5 mL of Persulfate oxidising solution to each Sarstedt vial for digestion, put the lid on tightly and mix well using vortex equipment. Loosen vial lid by half a turn back and place vial into digestion rack for the autoclave
- 5) Insert samples into autoclave and program autoclave cycle as detailed in Attachment 3.1.
- 6) Let samples cool before analysing or freeze for later analysis.

**Autoclave use**

- 1) For freshwater samples digest the samples, calibration standards, In-House Reference Materials and Certified Reference Materials in the autoclave at 121°C for a continuous

- period of 70 minutes
- 2) For saltwater samples, digest the calibration standards, In-House Reference Materials and Certified Reference Materials in the autoclave at 121°C for a period of 70 minutes,
  - 3) For samples of unknown salinity and having a salinity between that of fresh and full seawater, treat the samples as if they were seawater i. e. autoclave at 121°C for a period of 70 minutes.
  - 4) Ensure the external water supply to the right of the autoclave is filled with reverse osmosis water
  - 5) To change the autoclave cycle setting to the desired conditions, do the following:
    - a) Press “Optional Cycle” button
    - b) Press the down arrow button (▼) to reject use of default settings
    - c) Press the down arrow button (▼) to set the temperature to 121°C
    - d) Press “Start” button to proceed
    - e) Press Up arrow button (▲) to desired time (i.e., 35 or 70 minutes)
    - f) Press down arrow button (▼) for Optional Liquid Cycle
    - g) Press “Start” button for the cycle to commence
  - 6) A printer has been attached to the autoclave which will record autoclave conditions during the cycle
  - 7) Note the operator's name, date of use, cycle conditions and result of autoclave performance check in the logbook associated with the Harvey SterileMax Autoclave.

## Appendix A4: Dissolved Organic Carbon and Total Nitrogen Assay in Water using the Shimadzu TOC-L

### AIMS ATSOP-006

#### INTRODUCTION

Marine, estuarine and freshwater samples are analysed by the AIMS analytical technology laboratory for Dissolved Organic Carbon (DOC) and Total Nitrogen (TN) using the Shimadzu TOC-L with TNM-L. The instrument uses high temperature catalytic oxidation to convert organic carbon to carbon dioxide which is detected by NDIR detector, and nitrogen to nitrogen monoxide, which is reacted with ozone emitting light, which is detected by a chemiluminescence detector.

#### SCOPE

This procedure relates to the Shimadzu TOC-L systems in the analytical technology laboratory at AIMS. It includes the analysis of water samples for DOC and TN. Both instruments function in the same way, the procedure therefore relates to both.

#### RESPONSIBILITIES

It is the responsibility of the instrument user to ensure they are suitably trained and follow this procedure.

It is the responsibility of the instrument user to maintain a safe and tidy work area.

It is the responsibility of the instrument user to monitor the performance of the instrument and inform the AT lab coordinator of problems or anomalies.

It is the responsibility of the instrument user to perform routine maintenance as required.

The AT lab coordinator is responsible for scheduling service if required.

#### SIGNIFICANT HEALTH & SAFETY RISKS

Hazards	Risk	Control
Heat	Burn	Ensure instrument is completely cool before performing any maintenance.
Electrical	Electric shock	Clean any liquid spills immediately. Do not remove side/ back panels of instrument while connected to power supply.
Hydrochloric acid	Chemical burns Environmental damage	Always dilute acid in a fume hood. Do not allow acid release to environment. Wear gloves when handling acid

Ceramic fibre and quartz wool	Fibrous dust	Do not breathe dust, use in a fume hood.
Soda lime CO <sub>2</sub> absorber	Corrosive	Wear gloves when handling. Only open container in a fume hood.

## ENVIRONMENTAL CONSIDERATION

Hydrochloric acid may cause long term adverse effects in the aquatic environment. Do not allow release of HCl to the environment. Small amounts may be washed down the lab sink with large amounts of water.

## TOOLS & EQUIPMENT

- Shimadzu TOC-L with TNM-L and autosampler
- Suitable sample tubes
- Suitable pipettes
- Suitable laboratory glassware

## MATERIALS AND REAGENTS

- Concentrated hydrochloric acid
- Platinum catalyst
- Instrument air and Zero air
- DOC purchased standard or Potassium Hydrogen Phthalate
- Potassium Nitrate
- MilliQ water

## RECORDS

All usage, maintenance and troubleshooting of the instrument should be recorded in the instrument log. This should also include routine actions such as gas change. Processing templates are available in the AT lab Sharepoint. Results of in-house and consensus reference materials should be recorded on the trend logs stored in the AT lab SharePoint.

## PROCEDURE

### Solution Preparation

1M hydrochloric acid for column regeneration

- To a 1000mL volumetric flask, add approximately 600mL of MilliQ water
- In a fume hood, using a measuring cylinder, dispense 98mL of concentrated (32%) HCl and add to the volumetric flask. Mix well.
- Allow to cool and make to volume with MilliQ water.

0.05M hydrochloric acid for B type halogen scrubber

- The procedure for making 1M HCl should be followed, substituting 5mL of concentrated HCl

- Or a 20x dilution of 1M HCl in MilliQ water can be made
- 25% phosphoric acid IC reagent
- To a 250mL volumetric flask, add approximately 150mL of MilliQ water
- In a fume hood, using a measuring cylinder, dispense 50mL of concentrated (85%) phosphoric acid and add to the volumetric flask. Mix well.
- Allow to cool and make to volume with MilliQ water.

### Standard Preparation

Dry standard materials at 105°C for two hours, or overnight at 60°C, and allow to cool in a desiccator before use. Record the preparation of stock standards and working standards according to ATWI019.

1000ppm Stock DOC solution (certified prepared standards may also be purchased which may be of different concentration)

- To a 500mL volumetric flask, accurately weigh 1.0625g of potassium hydrogen phthalate standard material.
- Dissolve in and dilute to volume with MilliQ water.

1000ppm stock TN solution

- To a 500mL volumetric flask, accurately weigh 3.6095g of potassium nitrate standard material.
- Dissolve in and dilute to volume with MilliQ water.

Working standards

- To a 1000mL volumetric flask, add approximately 600mL of MilliQ water
- Add 10mL of concentrated HCl, mix well and allow to cool
- Add by pipette the required volume of stock DOC and TN standards (see table)
- Make to volume with MilliQ water and mix well

Standard	DOC 1000ppm stock volume (mL)	TN 1000ppm stock volume (mL)
0ppm	0	0
1ppm	1	0.1
2ppm	2	0.2

Other standard concentrations may be prepared depending on samples for analysis, it is recommended higher strength standards are used to extend the calibration curve rather than diluting samples.

Stock standards are stable in airtight glass containers for 6 months.

Working standards are stable for 2 months in airtight glass containers.

### Instrument Parameters

- Refer to AT work instruction XXX for instruction to setup the instrument
- Furnace temperature 720°C
- Carrier gas flow 150 ml/min
- Sparge gas flow ~100 ml/min. Sparge flow should be manually adjusted using the sparge gas valve on the instrument to produce a steady gentle stream of bubbles
- Injection volume: 200 µL

### Detection/ Integration Parameters (Sample/ Method Properties)

#### NPOC

- No. of Inj.: 3/4
- No. of wash: 2

- SD Max: 0.1
- CV Max: 2.0
- Sparge time: 7 minutes
- Peak Time Parameters: Use default settings
- Enable multiple injections

**TN**

- No. of Inj.: 3/3
- SD Max: 0.1
- CV Max: 2.0
- Peak Time Parameters: Use default settings
- 

**Method**

Method principle: Sample is pre-acidified to pH ~1-2 by addition of concentrated HCl to make 1% v/v (0.1mL HCl to 10mL sample). Inorganic carbon is converted to CO<sub>2</sub> and removed from the sample by sparging with CO<sub>2</sub> free gas. The remaining non-purgeable organic carbon (NPOC, also referred to as DOC) and total nitrogen (TN) is measured by high temperature catalytic oxidation as described in the introduction.

**Standard/ blank and reference material preparation**

- Prepare 10mL plastic sample tubes for the standards and blanks by rinsing with ~2% HCl. Tubes may be left to stand with the acid. Rinse the tubes with MilliQ water and dry inverted at 60°C.
- Add approx. 2-5mL of the standard to a cleaned tube, cap and shake well. Discard the contents and repeat the procedure twice.
- Fill the tube to 10mL mark and add to the instrument carousel in the required position.

**Unknown sample preparation**

- Samples should already be acidified by the customer. Samples should be stored in the refrigerator and allowed to equilibrate to ambient temperature prior to analysis.
- Shake samples well, remove the cap and check the pH of residual water in the cap using indicator paper.
- If samples have not been acidified, add 100µL of concentrated HCl to a 10mL sample and shake well. Make a note on the LIMS that the samples were not acidified on receipt when entering data.
- Add the tube to the required position in the carousel.

**Reference materials**

- Consensus reference seawater is available from the Hansell lab at the University of Miami. Sea surface reference (SSR) seawater should be analysed during each analysis and the results trended. Other suitable reference materials may be used.
- Inhouse reference seawater should be analysed during each analysis and the results trended.
- Obtain bulk seawater (GPA from Seasim is suitable) and acidify with HCl to 1% v/v.
- Store the bulk inhouse seawater in sealed glass containers.

**Sample Analysis**

- The analysis run should include at least five 0ppm samples at the start of the run which may be considered null or junk samples.
- Peak shapes and response should be assessed for these samples to ensure the instrument is functioning in an acceptable manner.

- Refer to appendix 1 for a typical analysis sequence.
- If samples contain more than 2ppm DOC, higher concentration standards should be added to each standard bracket.

### **Result processing and reporting**

- Templates to process the data are available in AT lab SharePoint > Documents > Processing Templates > Template for DOC V3 (Feb2021)
- Corrections for baseline drift and response drift are included in the processing.
- Calibration curves are produced for every run using all injections of the standards. Individual results may be omitted from the curve if they are clear outliers.
- Samples need to have the result corrected for the addition of the acid - for a sample with 1% HCl added, the result is multiplied by 1.01
- Summarise the results for reference materials and add the results to trend charts stored in SharePoint – AT Lab > Documents > TOC > DOC QC data

### **Quality Control/ System Suitability**

- The  $R^2$  value for both C and N calibration curves should be  $\geq 0.99$
- Record results for all injections of the reference materials in the trend logs.
- The mean recovery of reference materials for a run should be within 2 standard deviations of the average for the material recorded in the trend log. No single injection should be  $>3$  standard deviations from average.
- If any of these conditions are not met, a questionable result investigation should be initiated.

## **REFERENCES**

Shimadzu Total Organic Carbon Analyser TOC-L CPH/CPN user manuals

## Appendix 1

### Typical sample table

Start MQ

0ppm

0ppm

0ppm

0ppm

0ppm

Inhouse seawater reference

0ppm

0ppm

1ppm

1ppm

2ppm

2ppm

Inhouse seawater reference

Hansell SSR CRM

[Sample 1](#)

[Sample 2](#)

[Etc up to 12 samples](#)

Inhouse seawater reference

Hansell SSR CRM

0ppm

0ppm

1ppm

1ppm

2ppm

2ppm

Inhouse seawater reference

[Up to 12 samples](#)

Inhouse seawater reference

Hansell SSR CRM

0ppm

0ppm

1ppm

1ppm

2ppm

2ppm

Inhouse seawater reference

The number of standard and inhouse seawater injections may be reduced to accommodate larger numbers of samples. A single injection of 1ppm, 2ppm and inhouse seawater can be made in each standard bracket if required.

Repeated injection of seawater leads to eventual blockage of the combustion column, it is therefore recommended that the maximum number of seawater sample injections for a column is 60.

## Appendix A5: Measuring CDOM in water samples using the Shimadzu 1900UV-Vis spectrophotometer

### AIMS-SOP-EFWQ-v2.0

#### Document Details

<b>Implementation date:</b>	15/05/2021	<b>Authorised by:</b>	Ulysse Bove
<b>Edition No:</b>	2.0	<b>Responsible Officer:</b>	Daniel Moran
<b>Date of Issue:</b>	15/05/2021	<b>Review date:</b>	29/04/2024

#### TASKS INCLUDED IN THIS SOP

Measuring the chromophoric (or coloured) dissolved organic matter (CDOM) in seawater samples with a UV-Vis spectrophotometer.

#### PRINCIPLE AND RESPONSIBILITIES

CDOM is a term used to describe a group of mixed (and mostly undefined) organic compounds dissolved in natural waters that absorb ultraviolet or short-wavelength visible light. This method outlines the operation and calibration procedures for measuring CDOM using UV-visible absorption spectroscopy. The applied method is based on Nelson and Coble (2009) and has been partially updated based on Mannino *et. al.* (2019).

#### SIGNIFICANT HEALTH & SAFETY RISKS

Hazards	Risk	Control
Electrical	Electrical shock	Protect electronic components from water leaks/spills and clean up any spills immediately. Disconnect instrument before conducting maintenance or servicing. Call an electrician if you are not sure you can solve the problem safely.
Cleaning cuvettes and/or instrument with small volume of volatile flammable liquid (ethanol or isopropanol)	Electrical fire	Ensure instrument is turned off and has cooled down before cleaning it. Ensure enough time has passed for any residual flammable liquid to evaporate before turning the instrument ON.

#### PERSONNEL PREREQUISITES & COMPETENCIES

Laboratory safety induction  
 Read and understood the protocol  
 Trained by experienced technician

## TOOLS & EQUIPMENT

### Sample collection:

- 50 mL amber glass bottles, acid-washed and oven-dried (60°C)
- 60 mL sterile syringe
- 0.2 µm syringe filter (Pall Acrodisc, Supor membrane)
- Nitrile, PVC, or powder-free gloves

### Sample measurement:

- Two quartz cuvettes (10 cm path length)
- Kimwipes
- Milli-Q water, freshly collected from the dispenser
- Shimadzu UV-1900 Spectrophotometer
- Air-tight container containing 70% ethanol for storing cuvettes when not in use
- Isopropanol 100% (if required)
- Nitrile, PVC, or powder free gloves

## ENVIRONMENTAL CONSIDERATION

N/A

## CHEMICAL DISPOSAL

The chemical used for storing or cleaning the instrument is used in small volumes. It is a volatile solvent, which readily evaporates during the cleaning process. Any waste from this solvent would be evaporated in a fume hood when disposal is required.

## REFERENCES

Mannino, A., M. G. Novak, et al., 2019. Measurement protocol of absorption by chromophoric dissolved organic matter (CDOM) and other dissolved materials, In Inherent Optical Property Measurements and Protocols: Absorption Coefficient, Mannino, A. and Novak, M. G. (eds.), IOCCG Ocean Optics and Biogeochemistry Protocols for Satellite Ocean Colour Sensor Validation, Volume ###, IOCCG, Dartmouth, NS, Canada.

Nelson, N.B., and P.G. Coble, 2009. Optical analysis of chromophoric dissolved organic matter. Chapter 5 in: Practical Guidelines for the Analysis of Seawater, O. Wurl (editor), CRC Press, 401 pp.

## PROCEDURE

### 1. SAMPLE COLLECTION

- Collect a sub-surface water sample (using a clean Niskin bottle or other method). Samples should not break the water's surface because of potential contamination from surface films.
- Samplers should wear powder-free non-latex gloves while handling samples, and gloves should not come into contact with the sampled seawater.
- Rinse a sterile syringe with sampled seawater three times and empty it. Fill the syringe ~60 mL with sample and attach the 0.2 µm syringe filter. Push ~10 mL of sample through the syringe filter to prime the filter. Rinse the amber bottle with 2 rinses of ~10 mL filtered water.
- Push water through the filter and fill the glass amber bottle to the base of the bottle neck (minimum of 50 mL of sample is required). If filtering becomes very difficult (e.g., turbid water), stop filtering and replace the syringe filter with a new one. Remember to prime the filter with ~10 mL water before recommencing filling the bottle. Filtering should not require a large amount of force; pushing water through the filter with excessive force will cause the filter membrane to rupture and contaminate the sample.
- Label the bottle with unique identifier corresponding to the sample taken.
- Store sample at 4°C until analysis. Samples should be analysed as soon as possible, preferably within 4 to 24 hours, but no later than within 6 months of collection (Mannino et. al. 2019).

### 2. MEASUREMENTS

The following described protocol is specific to the Shimadzu UV-1900 spectrophotometer. However, any dual cell UV-Vis spectrophotometer with a wavelength resolution of 0.5 nm can be used.

Before starting measurements, bring the samples out of the cold room or refrigerator at least 2 hours before analysis and put them in the lab next to the spectrophotometer to equilibrate to room temperature. Space the samples from one another to ensure they warm to room temperature evenly. Do not begin analysing samples until they fully reach room temperature, as cold samples will result in inaccurate analyses.

While samples are coming to temperature, prepare the pre-set template (.csv) containing your sample details (see Table 1) and runsheet (see template at C:/UVVis-Data/Text/WQQ) with batch information and notes for each sample processing batch.

#### a. Initialising Spectrophotometer

- Turn on spectrophotometer (switch located lower right-hand side) and allow it 1 to 2 hours to warm up.
- Inspect the optical windows in the sample compartment. If necessary:
  - Remove and store safely the 1 cm cuvette inserts
  - Clean the light source and detector optical windows inside the sample compartment with lint-free optical lens cleaning tissue slightly moistened with isopropanol, followed by a gentle wipe with dry lens tissue to remove any

visible lint on the optical windows.

- Thoroughly rinse both cuvettes and fill with Milli-Q and wipe any excess liquid from the cuvette surfaces with a Kimwipe. Ensure that the contents are bubble-free and that the cuvette windows are clean. Place the cuvettes aside to equilibrate to room temperature.
  - Reference/blank cuvette is located at the back of cuvettes compartment
  - Sample cuvette is located at the front of the cuvettes compartment
- Press the grid button on the bottom left-hand corner of spectrophotometer display and select 'PC Control'.

#### b. Initialising instrument PC

- Turn on the PC.
- Open 'LabSolutions UV/Vis' software.
- Select 'Spectrum' which opens another window.
- In the new window, select 'Connect' to connect to the PC.
- Set the parameters by loading (file -> open -> parameters),
  - for CDOM spectrum analysis, parameters should be set as scanning in 0.5 nm intervals between 200-750 nm wavelengths
- Check that the Go To wavelength is set to 750 nm.
  - Click W.L. to confirm the Go To wavelength is set at 750 nm. Click OK.
- Conduct a baseline correction with Milli-Q water-filled cells in the sample (UWs) and reference (UWr) beams (Milli-Q to Milli-Q baseline correction) to zero the instrument for pure water. Once filled with Milli-Q and set into the cell holder, the reference cell should not need to be adjusted or changed. For this reason, it is preferable to place the cell cap on the reference cell to ensure no debris or dust settles into the reference cell throughout the sample analysis run.
  - Click BL to run a baseline correction absorption spectrum between 200 and 750 nm. This takes a couple of minutes to complete.
  - Record time of baseline correction on the runsheet.
- Fill in the file information or use the pre-set function by importing sample information from a pre-prepared .csv file and as per Table 1.

**Table 1. Example sample pre-set and nomenclature**

Scan order	Sample type	Sample name	Filename_vspd	Filename_csv_autoexport
1	blank	milliq_01_start	milliq_01_start.vspd	milliq_01_start_RawData.csv
2	sample	Sample_ID1	Sample_ID1.vspd	Sample_ID1_RawData.csv
3	sample	Sample_ID2	Sample_ID2.vspd	Sample_ID2_RawData.csv
4	sample	Sample_ID3	Sample_ID3.vspd	Sample_ID3_RawData.csv
5	blank	milliq_02_mid	milliq_02_mid.vspd	milliq_02_mid_RawData.csv

#### c. Running Blanks

- Milli-Q water blanks are run initially, after every ten samples and at the end of every run. The blanks should be labelled according to the format "milliq\_##\_<position>" with the numbers being allocated sequentially from start to end and the position being either start, mid (can have multiples) or end. See the pre-set template (and Table)

for further information.

- With the Milli-Q blanks in both cuvette holders (reference and sample cuvette), close cuvette compartment door.
- On PC control window press START to initialise scan. The scan will run from 750 nm to 200 nm in steps of 0.5 nm. The absorbance values must be recorded and reported to five decimal places.
- Check this initial spectrum scan to confirm that Milli-Q water absorption throughout 200 to 750 nm is close to zero.

**d. Running Samples**

- Open compartment door and leave open while changing samples to keep the compartment from heating up. Take the sample (front) cuvette out and rinse once with Milli-Q and twice with some sample water (these 2 rinses should be done so that there is enough sample water left to fill the cuvette entirely for sample readings).
- Fill the sample cuvette with sample water to just below the top of the cuvette. Leave the reference (back) cuvette in the spec.
- Clean the cuvette so that all external surfaces are dry and that the cell windows (ends) are free from water, fingerprints, and dust. Inspect the cell windows. Inspect the cell contents for small bubbles or particles. Place in the sample cuvette holder. Close compartment door.
- Make sure that the spectrophotometer reads  $0.000 \pm 0.002$  at 750 nm (Check the “live” absorbance reading on PC window). If not, remove the sample cell and check that there are no bubbles and that the cuvette windows are clean. Wipe the cell windows again with a fresh Kimwipe. Inspect the cell contents for contamination and if necessary, re-filter the sample using a fresh syringe and 0.2  $\mu\text{m}$  filter as per the field method above. If you are still having trouble, a new Milli-Q blank can be scanned before analysing more samples. You can also check the sample details as sometimes flooding event samples or river mouth samples with high absorbance may have live absorbance values at 750 nm of 0.002-0.003; otherwise, you may have to run a new Milli-Q baseline.
- On the PC control window press START to initiate scan.
- Check the scan is satisfactory and does not have any sharp peaks, cut-offs, or a shape that diverges from an exponential decay. If the scan is unsatisfactory then you may need to re-run the scan. Check the sample cell and reference cell as per the previous step and then re-run the scan. You will need to modify the pre-sets sheet to insert a line for the additional re-run scan. If unsatisfactory results persist there may be a problem with the sample or spec and you should speak with the lab manager. Make notes on the re-run in the sample batch runsheet.
- Once a satisfactory scan has been achieved, discard the sample, and rinse the cuvette three times with Milli-Q water and gently tap dry on a Kimwipe.
- Tapping should be done on a thick and soft pile of Kimwipes to avoid cracking or damaging the quartz cuvette. Microscopic cracks can occur in cuvettes, which are not visible to the naked eye, but nonetheless affect sample readings. Any tapping must be done with extreme care.
- Rinse the cuvette twice with some of the next sample water (ensure enough water is left for 3<sup>rd</sup> fill) then fill to just below the label on the cuvette with sample water and read as before.
- Repeat reading steps for remaining samples, ensuring a Milli-Q sample blank is read after every ten samples and at the end of the run.

- When finished, flush the cuvettes with Milli-Q water 3 times and store them in 70% ethanol to avoid algal growth.
- If air bubbles are adhering to the cell and are hard to dislodge by flushing, it may be necessary to clean the cell by soaking in 10% hydrochloric acid and rinsing with Milli-Q water.
- Close the 'LabSolutions UV/Vis' program and turn off the spectrophotometer.

### 3. CALCULATIONS

First, the absorption spectrum of the Milli-Q blank is subtracted from the sample absorption measured between 200 and 750 nm. The absorption coefficient at any wavelength,  $a_{CDOM}(\lambda)$  (in  $m^{-1}$ ), is hereafter calculated as:

$$a_{CDOM}(\lambda) = 23.03 \times [Abs(\lambda) - Abs(600-750)]$$

where:

- $Abs(\lambda)$  is the absorbance at wavelength  $\lambda$ ,
- $Abs(600-750)$  is the average absorbance between 600 and 750 nm, which corrects for the residual scattering by fine size particle fractions, micro-air bubbles, colloidal material present in the sample, or refractive index differences between the sample and the reference, and
- the factor 23.03 converts from decadic to natural logarithms and furthermore considers the cell path-length of 10 cm.

The CDOM spectral properties can thereafter be modelled as:

$$a_{CDOM}(\lambda) = a_{CDOM}(\lambda_0) \times EXP[-S \times (\lambda - \lambda_0)]$$

where:

- $a_{CDOM}(\lambda)$  is the absorption coefficient at wavelength  $\lambda$ ,
- $a_{CDOM}(\lambda_0)$  is the absorption at reference wavelength  $\lambda_0$ , and
- $S$  is the spectral slope coefficient.

### 4. DATA MANAGEMENT

The data acquired during analysis will be automatically saved locally on the PC controlling the spectrophotometer as:

- a .vspd file stored in "C:/UVVis-Data/Data/".
- a .csv file (this is stored in "C:/UVVis-Data/Text/").

- If required, csv file contents/formatting can be changed by clicking on Tools - > User Settings -> Text Output. However, this should not need to be changed frequently.

Both type of files can then be exported for further analysis if required.

## 5. QUALITY ASSURANCE AND CONTROL

CDOM samples are only analysed if the spectrophotometer has successfully passed its start-up sequence checks.

Special attention is taken toward the light source lamps (halogen and deuterium bulbs) which are changed according to manufacturer recommendation every 2000 hours.

During sample measurements, the sample absorption at 750 nm should be  $0.000 \pm 0.002$  nm. If different from this value, the samples and reference cuvettes are inspected for the presence of bubbles and cuvettes are wiped using Kimwipes. If required, a new Milli-Q blank can be scanned before analysing more samples. In severe cases, a new Milli-Q baseline correction can be conducted. Under some circumstances, samples with very high absorbance (i.e. samples from flood plumes) may give higher live absorbance readings at 750 nm, this should be taken into consideration if live absorbance values are high and persist despite checks.

## APPENDICES

*All appendixes must be referenced within the body of the SOP*

#.	
#.	
#.	
#	
#.	

## RECORDS

All AIMS analyses undertaken on behalf of AIMS or client must be recorded and stored as follows:

- Data must be lodged in a manner that complies with [External Document and Data Control Policy](#), [Data Access Policy](#) and AIMS Disaster Recovery Plan, and must have an associated metadata record (see for the Data Access Policy for full details).
- Raw experimental Measurement data must be stored as hard copy and digitally as specified by the External Document and Data Control Policy, and data from processing samples must be stored in the Data Centre with appropriate metadata (see this policy for other approved storage locations and requirements).
- The data custodian(s) is/are responsible for lodging the data and generating the metadata record.

## Appendix A6: Analysis of particulate phosphorus in marine waters

### AIMS-SOP-EFWQ-v2.0

#### Document Details

<b>Implementation date:</b>	15/05/2021	<b>Authorised by:</b>	Ulysse Bove
<b>Edition No:</b>	2.0	<b>Responsible Officer:</b>	Ulysse Bove
<b>Date of Issue:</b>	15/05/2021	<b>Review date:</b>	29/04/2024

#### TASKS INCLUDED IN THIS SOP

Analysis of total particulate phosphorus in seawater with a focus on detecting low level concentrations of bioavailable phosphorus.

#### PRINCIPLE AND RESPONSIBILITIES

The method is based on the oxidation of organic phosphorus and the extraction of acid-labile inorganic phosphorus from particles by hot acid persulfate (Menzel and Corwin, 1965) and the subsequent colorimetric determination of the phosphorus released as orthophosphate (Parsons et al, 1984).

Phosphorus occurs in many organic and inorganic forms in the environment. Forms available for quantitation by instrumental means depend strongly on the extraction method employed (e.g. Ruttenberg, 1992).

#### SIGNIFICANT HEALTH & SAFETY RISKS

Hazards	Risk	Control
Working with electrical appliance in close proximity to water	Electrocution	Use appropriate PPE including safety glasses, lab coat, and gloves. Use a RCD safety power outlet. Clean water spills immediately.
Exposure to hazardous chemical during preparation and dispensing	Chemical burns, chemical inhalation	Read the relevant MSDS. Use appropriate PPE including safety glasses, lab coat, and gloves. Label chemical solutions correctly. Clean any spills immediately and work with chemicals in a fume hood.

Boiling or heating water and hazardous chemical	Burns	Use appropriate PPE including safety glasses, lab coat, and gloves. Use marble stoppers to avoid vial reflux of solution without bumping. Allow samples to cool before removing from heating block.
Homogenizer shattering sample vial	Injury	Use appropriate PPE including safety glasses, lab coat, and gloves. Inspect vial integrity before use, turn homogenizer on before shaft inserted in vial and off before being removed. Perform homogenization while vial is in the foam holder.

## PERSONNEL PREREQUISITES & COMPETENCIES

Laboratory safety induction

Read and understood procedure

Trained by an experienced technician

## TOOLS & EQUIPMENT

### Sample collection

- 25 mm Whatman GF/F glass fibre filters, pre-combusted (4 hours at 450°C)
- Squares of aluminium foil (~8 x 8 cm), pre-combusted (4 hours at 450°C)
- Millipore forceps (2 pairs)
- Fine-tip permanent labelling marker
- 250 mL plastic graduated cylinder
- Filter funnels (25 mm) and filter supports
- Vacuum manifold, water trap and pump
- 60 mL sterile syringe and 0.2 µm syringe filter (Pall Acrodisc or similar)

### Sample analysis

- ***All plasticware and glassware should be well-rinsed, soaked in dilute Hydrochloric acid (HCl), rinsed again in Deionised Water and heat dried (where possible). Detergents, which may contain phosphates, must be avoided.***
- Automatic pipettes (50 µL, 100 µL, 250 µL, 500 µL, 1 mL, 5 mL and 10 mL)
- 2.5 mL dispenser on a reagent bottle for the persulphate digestion reagent
- 5 mL dispenser on a reagent bottle for deionized water
- 50 mL stoppered graduated measuring cylinder for making up mixed reagent

- 200 x 7 mL glass scintillation vials in 2 foam trays. One tray of vials (100) is to be used for the sample digestions and the other for the colorimetric analyses. Clean the glass vials in 10% HCl and oven dry. It is convenient to bake the vials at 450°C in a muffle furnace to remove the inked labels on used vials rather than wiping them off with solvent.
- 100 position heating block in a sand-filled electric frypan
- 100 small glass marbles (acid washed in 10% HCl, rinsed with deionised)
- Mini homogeniser with beaker of Milli-Q for rinsing
- Reagent bottles
- Millipore forceps
- 3 x 100 mL and 1000 mL volumetric flasks
- Safety glasses
- Spectrophotometer with 1 cm cell (capable of reading to 900 nm). Although not essential, an automated, low-volume, sipper cell attachment for the spectrometer will speed up analysis time considerably.
- Centrifuge (Eppendorf 5810 or equivalent)

### Chemicals and reagents

- Milli-Q water and reverse osmosis (RO) water
- Potassium persulphate ( $K_2S_2O_8$ , CAS No.77727-21-1): 15 g in 300 mL of Milli-Q water. Make fresh daily.
- Colour reagent:
  - a. Ammonium heptamolybdate [ $(NH_4)_6Mo_7O_{24}$ , CAS No. 12027-67-7]: 15 g in 500 mL of Milli-Q. This solution is reasonably stable (~3 months), but if kept for too long, a precipitate will form. If this happens, discard and make up a fresh solution, though small amounts of precipitate will not affect the analysis.
  - b. Sulphuric acid ( $H_2SO_4$ , CAS No.7664-93-9): Add 140 mL of concentrated (98%) sulphuric acid to 900 mL Milli-Q. Stable.
  - c. Ascorbic acid ( $C_6H_8O_6$ , CAS No.50-81-7): 2.4 g in 50 mL of Milli-Q. This solution is unstable. Freeze at -20°C in 10 mL portions and defrost as needed.
  - d. Potassium antimonyl tartrate [ $K(SbO)C_4H_4O_6$ , CAS No. 28300-74-5]: 0.34 g in 250 mL of Milli-Q. Stable.

#### Mixed Reagent:

- mix 10 mL of (a) with 25 mL of (b),
- add 10 mL of (c), and
- add 5 mL of (d).

This solution will remain stable for no longer than 4 hours.

- Standard solutions:

- 1 mmol L<sup>-1</sup> PO<sub>4</sub> primary standard: Dissolve 0.136 g of potassium dihydrogen phosphate, anhydrous (KH<sub>2</sub>PO<sub>4</sub>, CAS No. 7778-77-0) in 1000 mL of deionised. Freeze at -20°C in 10 mL portions and defrost as needed.
- Blank- Milli-Q
- 5 µmol L<sup>-1</sup> PO<sub>4</sub>: Pipette 0.5 mL of 1 mM PO<sub>4</sub> into a 100 mL volumetric flask and make to the mark with deionised water.
- 10 µmol L<sup>-1</sup> PO<sub>4</sub>: Pipette 1.0 mL of 1 mM PO<sub>4</sub> into a 100 mL volumetric flask and make to the mark with deionised water.
- 20 µmol L<sup>-1</sup> - PO<sub>4</sub>: Pipette 2.0 mL of 1 mM PO<sub>4</sub> into a 100 mL volumetric flask and make to the mark with deionised water.

## ENVIRONMENTAL CONSIDERATION

Avoid release of concentrated forms of used chemicals (reagents) into the environment.

## CHEMICAL DISPOSAL

Only small quantities of very dilute hazardous chemicals are used and as such do not require registered disposal methods. All liquid waste can be disposed of by dilution and flushing down laboratory sinks that flow to chemical waste sumps. These sumps are emptied periodically by a licenced contractor. Solid waste from GF/F filters is collected in traps and disposed in general laboratory waste.

## REFERENCES

Menzel, D.W. and Corwin, N. 1965. The measurement of total phosphorus in seawater based on the liberation of organically bound fractions by persulphate oxidation. *Limnology and Oceanography* 10: 280

Parsons, T.R., Yoshiaki, M. and Lalli, C.M. 1984. A manual of chemical and biological methods for seawater analysis, Pergamon, London. pp22-25

Ruttenberg, K.C. 1992. Development of a sequential extraction method for different forms of phosphorus in marine sediments. *Limnology and Oceanography* 37(7): 1460-1482.

Thompson M. and Walsh J. N. 1993 Handbook of Inductively Coupled Plasma spectrometry. 2nd ed. Chapman and Hall.

## PROCEDURE

### SAMPLE COLLECTION

- Filter 250 mL of seawater sample through a 25 mm Whatman GF/F glass fibre filter (through vacuum manifold or syringe filtering). Duplicate samples are recommended.
- The filter is then wrapped in aluminium foil, labelled with collection information and the volume filtered. When sampled in duplicate, there should be 2 filters per foil packet.
- Freeze the filters immediately (-20°C).
- Duplicate wet filter blanks should be collected once per day of sampling by filtering ~20 mL of filtered seawater (0.2 µm syringe filter) through a GF/F following the same procedures as for regular samples. Typically, sample water is used for this from the final sampling site of the day. Wet filter blanks are stored in the same manner as regular samples.

### ANALYSIS

- Place each sample filter in a uniquely identified 7 mL scintillation vial.
  - A duplicated pair of deionised water blank filters and four pairs of digestion/recovery standards (in duplicate) should be run in each digestion. The suggested range of controls is 0, 50, and 100 µL of the 1 mM primary standard solution per vial, corresponding to 0, 10, and 20 µM phosphate, respectively.
  - Sample vials should be numbered from 1 to 100 to be individually identifiable.
- Add 2.5 mL of potassium persulfate solution to each vial.
- Place vials in hot plate holder and put a clean glass marble on each vial to allow the sample to reflux while gradually evaporating to dryness.
- Turn on the fry pan/hot plate and adjust the temperature so the vials reflux gently (approx. 80 to 90°C, thermostat 7 to 8)
- When all vials are refluxed dry (~7 hours to overnight), allow to cool and then add 5 mL Milli-Q water to each vial. Cover with plastic wrap (e.g. Gladwrap, zip lock bag) and let stand overnight.
  - After refluxing, vials can be kept for 24 hrs in fridge before overnight Milli-Q incubation or alternatively kept in the freezer a few days before overnight Milli-Q incubation.
- The filters in each vial are homogenized using a small, motorized mixer made from a hobby engraver. Rinse the head of the mixer between samples in a beaker of clean Milli-Q water.
- After mixing, the solid particles in the vials are spun down in a centrifuge (2 x 3 minutes at 3500 rpm in Eppendorf 5810).

- It is advisable to stop the centrifuge midway through and gently shake the vials to “tap down” any filter particles that adhere to the sides. This will reduce the likelihood of particles contaminating the supernatant.
- Pipette exactly 2.5 mL of the supernatant into a clean 7 mL scintillation vial with the same numbering as the original scintillation vial.
  - 4 x pairs of calibration standards need to be prepared at this stage. See Calibration section below.
- Add 0.25 mL of colour reagent to each vial and mix gently.
- Allow the colour to develop for at least one hour. It may be necessary to remove them from the cool of the lab to a warm space outside as cooler temperatures will retard colour development leading to longer development times. The intensity of colour will plateau for a short while before slowly fading. Finding this optimal temperature window for colour development can sometimes prove problematic and so the “control standards” are essential to estimate efficiency.
- After 60 minutes (but in less than 2 hours) measure the absorbance of the solutions in the vials at 885 nm on a spectrophotometer using a 1 cm cell.
  - The colorimetric method is linear over the range 0 to 20  $\mu\text{mol L}^{-1}$  phosphate in solution corresponding to spectrophotometer readings of 0 to 0.400 AU. Hence, readings above 0.400 AU will not yield accurate phosphate estimation and in this case the samples need to be diluted.  
For these samples as well as recovery standard (vial 1-3 pairs), within 1 hour of initial preparation:
    - Re-spin the original sample vial in which the filter was ground for 3 minutes @ 3500 rpm
    - Carefully pipette out 0.8333 mL of sample into a clean 7 mL vial and add 1.66 mL of Milli-Q water (corresponding to a 3-fold dilution factor)
    - Prepare a fresh batch of calibration standard
    - Add 2.5 mL of colour reagent (can be used for 4 hours from preparation time)
    - Incubate for 1 hour and repeat spectrophotometer reading
- All measurements should be recorded on the sample analysis logsheet (Appendix 1).

## CALIBRATION

- A series of phosphate standard concentrations is run each time a batch of sample is analysed to create a standard curve which should be linear up to at least 20  $\mu\text{mol L}^{-1}$ . This curve measures the level of colour development but does not account for matrix effects caused by persulphate digestion and sample handling etc. Digestion/recovery standards are to be run with each batch of samples for this purpose. With each batch, a series of phosphate standard concentrations and a set of blank filters are digested and treated in the same way as the samples to

determine efficiency of the analysis process. An efficiency factor is then imposed on the whole batch.

### Standard Curve

A standard curve of 0, 5, 10 and 20  $\mu\text{mol L}^{-1}$  phosphate (prepared from the 1 mM primary standard) is run with each sample plate.

The slope is calculated and used to convert the sample absorbance (with correction for blank) to phosphate concentration in the sample.

The efficiency factor and a dilution factor are then applied to calculate the phosphorus content of the sample.

The final value should be the concentration of particulate phosphorus, in  $\mu\text{mol L}^{-1}$ .

### Blanks

Wet filter blanks are collected during sample collection and are run with each sample batch. The average absorbance is subtracted from both the samples and the recovery standards to calculate the effects of handling and suspended particle interference.

## **CALCULATION**

Phosphorus concentration may be calculated using the following equations. The equations assume that the filtered sample volume is 250 mL and that there is 5 mL of Milli-Q resuspension. The calculation spreadsheet (Appendix 2) allows for variation of these numbers for individual samples.

$$F = \frac{\text{concentration of standard } (\mu\text{mol L}^{-1})}{\text{AbsStd} - \text{AbsBlank}}$$

For a given standard concentration and a 1 cm spectrophotometer cell, the value of F should be very close to 50. When using spec cells of other pathlengths, divide F by the pathlength in cm.

$$\text{efficiency} = \frac{\text{measured concentration of control standard}}{\text{real concentration of control standard}}$$

$$\text{dilution factor} = \frac{\text{initial volume of sample (i.e. 250 mL)}}{\text{concentrated volume of sample (i.e. 5 mL)}}$$

- For samples that have undergone further dilution due to initial spectrophotometer readings  $>0.400$  AU, calculations are similar to previously described but based on diluted recovery and calibration standard. Final phosphorus concentrations are multiplied by 3 to account for extra dilution.

## METHOD CAPABILITIES

The colorimetric method is linear over the range 0 to 20  $\mu\text{mol L}^{-1}$  phosphate in solution (or 0 to 0.100  $\mu\text{mol}$  of total phosphorus per filter).

Samples with phosphate concentrations above this range (as is often the case with river or estuarine samples) will need to be diluted before the colour reagent is added.

Where high phosphorus concentrations are likely, it may be beneficial to filter a few extra samples that can be used to establish approximate concentration ranges.

## DATA MANAGEMENT

- The sample identifier and volume filtered is logged on a laboratory worksheet against the vial into which it is being placed (Appendix 1). The spectrophotometer absorption reading for each sample is then written on this sheet.
- All information from this lab sheet is then entered into a Microsoft Excel spreadsheet template called "Particulate phosphorus calculation sheet" (Appendix 2) which is a visual copy of the laboratory form but has all the calculation equations embedded.

## QUALITY CONTROL

QA/QC tests undertaken as part of the data reporting include:

### Assessment of the limit of detection

- The Limit of Detection (or detection limit) is the lowest concentration level that can be determined to be statistically different from a blank (3 standard deviations = 99% confidence).
- Minimum detection limits were calculated for this method using repetition of blanks.
- The effective detection limit is 0.010  $\mu\text{mol P}$  (0.310  $\mu\text{g P}$ ) on a filter.

### Assessment of accuracy of the analysis

- This is generally achieved by using reference materials to assess recovery of known amount of analyte.
- There is no certified reference material available in the particulate phosphorus concentration range of Great Barrier Reef marine samples. Hence, no direct assessment of accuracy is possible for this method.
- As an indirect assessment, a set of separate phosphate recovery and calibration standards is analysed to determine a method efficiency factor for each analytical batch. Analytical data are adjusted using the batch-specific efficiency factor. If for a given analytical batch the phosphate recovery after persulfate digestion is calculated to be less than 90%, all samples within this analytical batch are rerun.

### Assessment of precision of the analysis

- This is generally achieved by the repeated analyses of the same concentration of analyte to check for reproducibility.

### Procedural blanks

- Filter blanks are run with every batch (generally daily) from dry, fresh GF/F filters. These are used as blank readings in the calculation of recovery.
- A pair of wet filter blanks (WFB) are collected during each sample collection to measure contamination of GF/F filters or through handling. The WFB phosphorous value is subtracted from all the filters collected on a similar trip to normalize the results and account for any contamination.

### Reproducibility of duplicate analytical units

- The variation between results for sample duplicates indicates the reproducibility of the analysis and the effects of various sources of contamination and analytical error during collection, sample preparation and analysis. Before data analysis, duplicate samples are used to calculate the coefficient of variance (CV) for each sample. Duplicates with CV outside a pre-determined confidence range (20%) are marked for re-run analysis performed using duplicate spare samples.

### Others

- Intercalibration of this method with the ICP method used by AIMS laboratories (Thompson and Walsh, 1993) showed agreement of +/- 15%.
- The linear range of this method was established utilising increasing concentrations of primary standard. Samples are diluted if above this range.
- A reference curve is generated with every sample batch.

## APPENDICES

*All appendixes must be referenced within the body of the SOP*

#.1	Phosphorus analysis logsheet
#.2	Particulate phosphorus calculation sheet
#.	
#	
#.	

## RECORDS

All AIMS analyses undertaken on behalf of AIMS or client must be recorded and stored as follows:

- Data must be lodged in a manner that complies with [External Document and Data Control Policy](#), [Data Access Policy](#) and AIMS Disaster Recovery Plan, and must have an associated metadata record (see for the Data Access Policy for full details).
- Raw experimental Measurement data must be stored as hard copy and digitally as specified by the External Document and Data Control Policy, and data from processing samples must be stored in the Data Centre with appropriate metadata (see this policy for other approved storage locations and requirements)
- The data custodian(s) is/are responsible for lodging the data and generating the metadata record.

## Appendix A7: Carbon and Nitrogen Assay in Solids using the Shimadzu TOC-L with SSM

### AIMS ATSOP-003

#### INTRODUCTION

Sediment and filters are analysed by the AIMS analytical technology laboratory for Carbon and Nitrogen using the Shimadzu TOC-L with TNM-L and solid sample module (SSM). Samples may be analysed for total carbon (TC), organic carbon (OC) or inorganic carbon (IC). The SSM can be used for acidification of samples and direct measurement of IC, however this method is not currently being utilised in the AT lab and is therefore not included in this procedure. TC and OC can be measured, and the IC content calculated as the difference.

#### SCOPE

This procedure relates to the Shimadzu TOC-L with SSM in the analytical technology laboratory at AIMS. It includes the analysis of sediments and filters for TC, OC, N, and the indirect analysis of IC in sediments as the difference between TC and OC.

#### RESPONSIBILITIES

It is the responsibility of the instrument user to follow this procedure

It is the responsibility of the instrument user to obtain the appropriate training in the use of the equipment

It is the responsibility of the instrument user to maintain a safe and tidy work area

It is the responsibility of the instrument user to monitor the performance of the instrument and inform the AT lab coordinator of problems or anomalies.

The AT lab coordinator is responsible for scheduling maintenance and arranging service if required

#### SIGNIFICANT HEALTH & SAFETY RISKS

Hazards	Risk	Control
Ceramic boats are heated to 950°C during and prior to analysis	Burn	Always use tools to move boats. Wear heat resistant gloves when removing boats from furnace. Allow furnace to cool to <200°C before removing boats.
SSM chamber heated to 950°C	Burn	Ensure SSM has completely cooled and power supply is disconnected before performing any maintenance
Hydrochloric acid	Chemical burns Environmental damage	Always use acid in a fume hood. Exercise extreme caution and wear suitable PPE when adding acid to boats, particularly to sediments containing carbonates. Do not allow acid release to environment.

## ENVIRONMENTAL CONSIDERATION

Hydrochloric acid may cause long term adverse effects in the aquatic environment. Do not allow release of HCl to the environment. Small amounts may be washed down the lab sink with copious amounts of water.

## TOOLS & EQUIPMENT

- Shimadzu TOC-L with TNM-L and SSM
- Labec muffle furnace
- Suitable tweezers, tongs, heat resistant gloves
- Hot plate
- Fume hood
- Ceramic boats
- Pipette

## MATERIALS AND REAGENTS

- Concentrated hydrochloric acid
- Sediment reference materials
- Platinum and Cobalt oxide catalysts
- Instrument air
- High purity oxygen

## RECORDS

All usage, maintenance and troubleshooting of the instrument should be recorded in the instrument log. This should also include routine actions such as gas change. Processing templates are available in the AT lab Sharepoint. Results of in-house reference sediments should be recorded on the trend log stored in the AT lab SharePoint

## PROCEDURE

### Preparation of ceramic boats

Boats should be freshly prepared for analysis; they may be used up to 1 week after burning if covered by foil. The boats used for a day's analysis must all come from the same tray.

- Used ceramic boats should have any residue brushed away or scraped using tweezers.
- Wash boats with tap water, scrub any residue with a brush
- When clean, rinse boats twice with RO water
- Place in drying oven until dry
- Arrange boats facing upwards in a ceramic tray suitable for the furnace. Boats may be in two layers if there are gaps in the top layer
- Place in furnace and heat to 950°C for 4 hours
- Boats may be removed when furnace has cooled to <200°C
- Using long handled tongs and heat resistant glove, remove tray of boats and place on ceramic mat and cover with a double layer of aluminium foil.
- Allow to cool to ambient temperature before use
- Storage boxes with 10 spaces are available to aid sample identification and preparation
- Use tweezers to place boats into storage boxes

## Instrument Start-up

In this configuration, the SSM is connected directly to the detectors of the TOC-L, the sampler and column of the TOC are therefore not used

- Check the instrument air and oxygen cylinders are sufficiently full for analysis, turn on the air cylinder, the oxygen should already be on
- Instrument air regulator set point – 200kPa
- Oxygen regulator set point – 200kPa
- Check the halogen scrubbers are suitable. The copper wool should be a bright copper colour with only slight blackening.
- Check the SSM boat holder is functioning correctly and is not too loose or tight when sliding in and out of the furnace.
- Increase flow of carrier gas to 0.6 on the controller on front of SSM
- Ensure there is power to TOC and SSM, turn on TOC. SSM temperatures should begin to increase
- Turn on PC (password Abcde123) and open TOC-L software Sample Table Editor. Click 'OK' without entry in username pop-up
- Click 'New' in left column or 'File' → 'New' → 'Sample Table'
- Select TOC TN SSM then click Ok
- Click 'Insert' → 'Multiple Samples'
- Select TC\_TN SSM.met as the method from the drop-down list, click 'Open'
- Click 'Next' and enter the number of samples (E.g. 60), click 'Finish'
- Click 'Connect' to connect to the instrument, the SSM will begin to heat if it has not already started to do so.
- SSM temperature: TC/TOC (left) – 950°C, TIC (right) – 200°C
- Click 'Monitor'. The baseline of the N and C channels will be displayed and the status of these. Zoom to an appropriate level. Typically, the N baseline will be flat while the C baseline tends to slope downwards and becomes more stable with time. If there is a lot of noise in the baselines, troubleshooting may be required.

## Standard/ Reference Preparation

- A reference material with certified amounts of C and N is used to construct a calibration curve by weighing varying amounts of the material.
- A six point calibration is used in addition to an empty boat as zero point.
- The mass of the highest calibration point should be selected to be close to the maximum peak height detectable by the instrument without truncation.
- The most accurate calibration will be achieved by uniform spacing of the standard weights.
- Record weights to an accuracy of 0.01mg
- Weigh 2 or 3 replicates of in-house reference materials and 2 or 3 additional replicates of the calibration standard
- These reference materials should be run periodically through the day to monitor drift
- All reference materials are stored in desiccators away from direct sunlight.

## Procedure

- Using tweezers, remove a ceramic boat from the covered storage box, place on the balance and tare
- Add the required amount of material to the boat and record mass.
- Return boat to covered storage box to prevent airborne contamination

Note – do not attempt to remove material from the boat to reduce mass, reject and re-weigh if mass is too high.

## Sample Preparation

### 1.1 Sediment Samples Total Carbon and Nitrogen

- Using tweezers, remove a ceramic boat from the covered storage box, place on the balance and tare
- Add the required amount of material to the boat and record mass.
- Return boat to covered storage box to prevent airborne contamination

### 1.2 Sediment Samples Total Organic Carbon and Nitrogen

- Using tweezers, remove a ceramic boat from the covered storage box, place on the balance and tare
- Add the required amount of material to the boat and record mass.
- Return boat to covered storage box to prevent airborne contamination
- To each sample, in a fume hood, add 100 $\mu$ L of concentrated HCl. The sample will fizz as inorganic carbon is dissolved and evolved as gas. More acid may be required if the IC content is high.
- Place the acidified sample on a hot plate at 80°C in the fume hood and allow to dry
- Return boat to covered storage box to prevent airborne contamination once dry

### 1.3 Filter Samples (Particulate Carbon and Nitrogen)

- Filters should be received frozen and remain so until analysis
- Using tweezers, remove a filter from the foil wrap and place in a ceramic boat
- In a fume hood, add 100 $\mu$ L of concentrated HCl to the filter (if the filter is 45mm diameter, more acid may be required)
- Place the acidified sample on a hot plate at 80°C in the fume hood and allow to dry
- Return boat to covered storage box to prevent airborne contamination once dry

## Sample Analysis

- When ready to start analysis, check the baselines are stable and close the monitor window
- Click 'View' → 'Sample Window'
- Click 'Start', enter the date followed by incremental number as file name e.g. YYYY\_MM\_DD\_001. This will be selected by the software by default. If a second run is started on the same day, it will be named YYYY\_MM\_DD\_002
- Click 'Save'
- Sample names are not entered into the Shimadzu software, the injection number of each analysis should be noted on the excel sheet used for processing.

## Procedure

1. Open the sample chamber and, using tweezers, place ceramic boat in the holder. Close the chamber and set alarm for 2 minutes. Click 'Set', the start button should be grey at this time and the software will indicate instrument not ready
2. After 2 minutes the instrument should be ready and the start button active – if not, troubleshooting will be required
3. Click 'Start' and push the sample into the furnace.
4. Peaks will appear after about 30 seconds

5. When the C and N traces are both more than halfway back to the baseline, pull the sample slide back to the cooling position. Set a timer for 2 minutes.
6. After 2 minutes the sample slide may be pulled completely out
7. A results box will popup when the sample analysis is finished
8. Record the C and N peak areas on the excel spreadsheet
9. Remove the analysed boat with tweezers, put in heat proof tray
10. Continue from step 1.

### **Analysis sequence**

- Begin the analysis with an empty boat. This may be considered a 'junk' sample
- Re-analyse the same boat that has just been run without removing from the system. This will indicate the system blank, response should be very small, if peaks are present it may indicate the instrument has not settled yet. Repeat the analysis of the same boat.
- Analyse another empty boat from the same batch used to prepare the samples for the day's analysis. This is the calibration blank used as the 0mg point in the calibration curve.
- Analyse the calibration standards in ascending weight order, the curve fit for C should be linear, and for N quadratic
- Analyse 1-2 inhouse reference materials to check response then proceed with sample analysis
- Reference materials should be analysed approximately every 10 samples to check instrument performance and drift.

### **Quality Control/ System Suitability**

The R<sup>2</sup> value for both calibration curves should be  $\geq 0.99$ . Points may be removed if they are obviously outliers, but the curve should contain at least 5 points in addition to the 0 point.

The recovery of inhouse reference materials should be 90 - 110% of expected based on the running average recorded in the trend logs.

Recovery of drift samples of the calibration material run throughout the day should be 95 - 105% of expected value

If any of these criteria are not met, investigation should be carried out and a nonconforming results investigation initiated.

### **Shutdown**

- When the last sample is finished, click 'Stop' in the measurement window
- Click 'Shutdown' then 'Ok'. The instrument will start to cool
- The software may be closed, and the computer turned off at this point
- Turn off the Instrument Air cylinder
- Reduce flow of oxygen to approximately 0.1 using the regulator on the SSM
- Allow the SSM to completely cool before power is turned off

### **Maintenance**

- Replace the halogen scrubbers every 12 months or when excessive blackening is apparent
- Replace the CO<sub>2</sub> scrubber every 12 months
- Replace the airlock o-rings as required (if leaking)
- Ensure the burred nut where the slider enters the airlock is tight
- A build up in back pressure may indicate the combustion column is partially blocked, this is most likely to occur in the narrow tube after the furnace. A slight hiss when the airlock is opened is normal, if this becomes louder or the sample slide is pushed back by the gas, perform maintenance as follows:
- Ensure the SSM is completely cool and disconnected from power source

- Lift the top cover and unplug the fan to allow complete removal of the cover
- Loosen the 2 screws on the front of the sample slide
- Loosen the 4 large screws on the sides of the airlock
- Open and slide back the airlock cover
- Loosen the nut on the rear of the combustion tube and carefully disconnect the elbow fitting. This fitting commonly becomes slightly blocked it should be cleaned by sonication in 1M HCl
- Undo the large nut on the rear of the airlock
- The airlock assembly may be removed leaving access to the combustion column which may be removed from the furnace
- The catalyst should not need replacing, however if a decline in performance is suspected of being caused by poor catalyst function it may be replaced. The catalyst is a mixture of; 50g of Cobalt tetroxide and 20g of Platinum on aluminium support. Approximately 45g is needed for the combustion tube.
- To pack the column, insert a mesh screen followed by 2.5mm of quartz wool. Add approximately 75mm of catalyst followed by 2.5mm of quartz wool and another mesh screen
- The combustion tube may be cleaned by soaking in 1M HCl
- Following repacking or removal of the combustion column, the system should be heated to working temperature for a few hours before samples are analysed, trial samples should be run during this time to check performance.

### Troubleshooting

- Build-up in back pressure and/or poor peak shape may occur with time due to partial blockage of the combustion column. Follow maintenance in section 9
- Leaks may occur particularly at any o ring or junction around the sample block. Leaks may cause poor peak shape or changes to response. Follow procedures in SSM-5000A manual for maintenance and troubleshooting if suspected
- Poor peak shape, such as double peaks may be caused by:
  - Insufficient acid or drying time
  - 45mm filters generally produce poor peak shape, typically with an early C spike
  - Contamination of boats
  - Gas leaks
  - Some sediments will have a double C peak in TC analysis, where the organic C is combusted first followed by the inorganic C. This is normal, in-house sediments which show this pattern are available and should be analysed for reference.
  - If a problem with the detector is suspected due to a high background and all other troubleshooting has not identified an issue, contact Shimadzu support. A re-zero of the detector may be possible.

### REFERENCES

Shimadzu Total Organic Carbon Analyser TOC-L CPH/CPN and SSM-5000A user's manuals

## Appendix A8: Analysis of Chlorophyll-a in marine waters

### AIMS-SOP-EFWQ-v1.0

#### Document Details

<b>Implementation date:</b>	15/05/2021	<b>Authorised by:</b>	Ulysse Bove
<b>Edition No:</b>	1.0	<b>Responsible Officer:</b>	Ulysse Bove
<b>Date of Issue:</b>	15/05/2021	<b>Review date:</b>	29/04/2024

#### TASKS INCLUDED IN THIS SOP

To measure the concentration of chlorophyll-a and phaeophytin-a present in seawater to obtain an estimation of phytoplankton biomass.

#### PRINCIPLE AND RESPONSIBILITIES

This method utilises the natural fluorescence of chlorophyll-a (Chl-a) to derive the concentration of the pigment present in an extract of material filtered from seawater. The fluorescence of decomposition products (phaeophytin-a) can cause significant interference. This method compensates by taking an additional fluorescence reading after acidification of the original sample (by which all pigments present are decomposed) and using the decreased fluorescence reading to derive the original concentration of live pigment.

This method follows the basic fluorometric method set out in Strickland and Parsons (1972). The concentration of the primary standard used for calibration is determined spectrophotometrically using the equations laid out in Jeffrey and Humphrey (1975).

#### SIGNIFICANT HEALTH & SAFETY RISKS

Hazards	Risk	Control
Chemical preparation and handling (90% Acetone and 10% HCl)	Chemical splash, spillage, or fume inhalation	Knowledge of the MSDS. Use appropriate PPE including safety glasses, lab coat, and gloves. Work with chemical materials within a fume hood. Ensure samples are capped properly when handling outside of the fume hood.
Manual handling	Biomechanical	Reach ergonomic position when working within the fume hood and using the tissue grinder. Organize the workstation to avoid repetitive strain injury. Take regular breaks.
Shattering glass tubes during sample processing	Injury	Use appropriate PPE including safety glasses, lab coat, and gloves. Inspect glass tubes and grinder before use.

Unbalanced centrifuge	Injury	Receive training in centrifuge use by experienced technician. Ensure centrifuge is balanced before closing the lid.
Electrical	Electrical shock	Protect electronic components from water leaks/spills and clean up any spills immediately. Disconnect instrument before conducting maintenance or servicing. Call an electrician if you are not sure you can solve the problem safely.
Exposure to UV light	Injury	Do not attempt to open the fluorometer housing while the instrument is running.

## PERSONNEL PREREQUISITES & COMPETENCIES

Laboratory safety induction

Read and understood protocol

Training by experienced technician

## TOOLS & EQUIPMENT

### EQUIPMENT

- 25 mm Whatman GF/F glass fibre filters, pre-combusted (4 hours at 450°C)
- Millipore forceps (2 pairs)
- Squares of aluminium foil (~8 x 8 cm), pre-combusted (4 hours at 450°C)
- Labels for tubes (pre-printed)
- 100 mL graduated measuring cylinder
- 25 mm filter funnels and supports
- Vacuum manifold, water reservoir, vacuum tubing, and vacuum pump
- Turner Designs Model 10-AU fluorometer
- 10 mL round quartz cuvette
- High speed tissue grinder comprising motor, pestle, and tube (Potter Elversham No. 23)
- 12 mL centrifuge tubes with caps pre rinsed with 90% acetone
- Centrifuge with 12 mL holders
- Plastic Pasteur pipette
- Kimwipes

### CHEMICALS

- 90% acetone – 900 mL of analytical grade acetone in 100 mL of Milli-Q water
- 10% hydrochloric acid – 10 mL of analytical grade hydrochloric acid in 90 mL of Milli-Q water

## ENVIRONMENTAL CONSIDERATION

Avoid the release of concentrated hazardous chemicals (100% acetone, 37% HCl) in sewage waste stream by either evaporation or dilution.  
Avoid release of ground GF/F filters in sink by filtrating and discarding appropriately the 90% acetone/ground GF/F waste.

## CHEMICAL DISPOSAL

90% acetone is evaporated in fume hood for 24 hours before water residue is poured down the laboratory sink.

## REFERENCES

Jeffrey, S.W. and G.F. Humphrey, (1975). New spectrophotometric equations for determining chlorophylls *a*, *b*, *c*<sub>1</sub> and *c*<sub>2</sub> in higher plants, algae and natural phytoplankton. *Biochem. Physiol. Pflanzen*, 167: 191-194

Strickland, J.D.H. and T.R. Parsons, (1972). *A Practical Handbook of Seawater Analysis*, Bull. Fish. Res. Board Can.167.

USEPA METHOD 445.0: In vitro Determination of chlorophyll *a* and phaeophytin *a* in marine and freshwater phytoplankton by fluorescence, United States Environmental Protection Agency Methods for the Determination of Chemical Substances in Marine and Estuarine Environmental Samples, EPA/600/R-92/121.

Turner Design Model 10AU fluorometer user's manual, April 1999

## PROCEDURE

### SAMPLE COLLECTION

- Filter 100 mL of seawater sample through a 25 mm Whatman GF/F glass fibre filter (through vacuum manifold or syringe filtering). Duplicate samples are recommended.
- The filter is then wrapped in aluminium foil and labelled with collection information. The volume of seawater filtered is recorded. When sampled in duplicate, there should be 2 filters per foil packet.
- Freeze the filters immediately (-20°C).

### TURNER DESIGNS 10AU FLUOROMETER CALIBRATION

The Turner Designs 10AU Fluorometer needs to be turned "ON" for at least 1 hour before any calibration or measurement can be undertaken. This ensures that the UV

light source has reached the appropriate spectrum and temperature for accurate measurements.

A simple way to optimise the fluorometer for this analysis method is to use a factory-supplied Solid State Standard (SSS) and set it to read 1.000 Mv in its "L" position (please note that not all SSS are the same and cross calibration may be required if a new SSS is purchased). The routine for adjusting the fluorometer using this SSS is shown in Appendix 1. You will need to have the machine manual on hand to do the initial set up of the machine.

Although very stable, the calibration of the fluorometer should be affirmed every 12 months using the chlorophyll-a calibration and door factor assessment methods described in Appendix 1. A worksheet showing the calibration method is shown in Appendix 2.

Fluorometer recalibration and door factor assessment is also required if the factory solid state standard (SSS) no longer reads 1.000 +/- 0.050, the lamp has been changed, service has been done, or the instrument has been moved.

#### **a. Calibration Control (daily)**

Each fluorometer has a manufactured fluorescence SSS that can be used for a daily working calibration or to calculate drift. Insert the standard at the beginning and end of each set of samples read and at regular intervals throughout the set. Make sure the "L" marking on the barrel is placed toward the left-hand side of the holder. A record is kept of the Solid Standard measured at the time of machine calibration and drift should be corrected referring to this original measurement (Appendix 3).

$$\text{Drift corrected } C_a = (\text{Calculated } C_a \times \text{Original Solid Standard}) / (\text{Measured Solid Standard})$$

where:

$$C_a = \text{concentration of chlorophyll-a in } \mu\text{g L}^{-1}$$

If at the beginning of the day the reading shows greater than 5% variation from the original, the emission and excitation filters of the fluorometer may need to be cleaned with an ethanol dampened tissue.

### **SAMPLE ANALYSIS**

- Chlorophyll-a, especially when extracted, is extremely light sensitive. All extractions must be carried out in the dimmest light possible. When not using extracted solutions, keep them wrapped to exclude light and store in a refrigerator. Keep extracted samples in a closed box or cover with a black cloth.

- Chlorophyll-*a* is rapidly and irreversibly degraded by acid, which converts active chlorophyll-*a* to phaeophytin-*a*. Do all sample grinding, extractions, and analyses in the designated chlorophyll-*a* fume hood. Do not use acids (especially HCl) in this fume hood.
  - Keep all equipment used for chlorophyll-*a* analysis free of acid.
- 1) Grind the filters in 90% acetone in a tissue grinding tube, including a dry filter blank sample for calibration and calculations.
  - 2) Pour suspension into a labelled graduated 12 mL centrifuge tube and make up to 10 mL with fresh 90% acetone while cleaning grinding tube.
  - 3) Cap graduated tube and shake.
  - 4) Clean and rinse tissue grinding tube with 90% acetone and remove any excess filter from tissue grinding pestle after each sample.
  - 5) Leave the tubes to stand in the dark for 2 hours. Either cover the box of extracted samples or cover the tubes with a thick black cloth to block out ambient light.
  - 6) Centrifuge for 10 minutes at 3500 rpm.
  - 7) Rinse round quartz cuvette 3 times with 8 mL of 90% acetone and discard acetone in an evaporation beaker.
  - 8) Dry the rim of the cuvette with Kimwipes.
  - 9) Transfer approximately 8 mL of the sample extract supernatant to the quartz round cuvette (up to the arrow marking on cuvette).
  - 10) Wipe the side of the round quartz cuvette with Kim wipes.
  - 11) Insert in the cuvette holder and replace cap on the holder.
  - 12) Read the fluorescence of the sample. Make note of reading on “F-orig” column on worksheet (Appendix 3)
    - a. If the reading on the fluorometer exceeds 1.5 Mv, sample dilution will need to be carried out to obtain accurate results.
    - b. According to the initial fluorometer readings, dilute 1 to 5 mL of sample supernatant in a known volume of 90% acetone using a clean 12 mL tube and an accurate pipette.
    - c. Repeat sample analysis from step 6.
    - d. Write down the dilution factor for this sample on the worksheet (Appendix 3).
  - 13) Add 2 drops of 10% HCl in the sample cuvette using a plastic Pasteur pipette. Allow the acid to react and take another reading. Make note of reading in the “F-acid” column on the worksheet (Appendix 3)
  - 14) An unused blank GF/F filter should also be processed in the same manner to give a blank value.

A simplified flow chart of sample analysis is shown in Appendix 5.

## CALCULATIONS

Chlorophyll-*a* and phaeophytin-*a* may be calculated using the following equations. The equations assume that the filtered sample volume is 100 mL and that there is 10 mL of

acetone extract. The calculation spreadsheet (Appendix 4) allows for variation of these numbers for individual samples.

$$C_a = F_D''(R_B - R_A)$$

$$\text{Phaeo} = F_D''(2.2R_A - R_B)$$

where:

- $C_a$  = concentration of chlorophyll-a in  $\mu\text{g L}^{-1}$
- Phaeo = concentration of phaeophytin-a in  $\mu\text{g L}^{-1}$
- $F_D''$  = door factor (see Appendix 1)
- $R_B$  = reading before acid addition-blank
- $R_A$  = reading after acid addition-blank

If volume filtered or volume of acetone were to differ, the values for  $R_B$  and  $R_A$  are calculated as followed:

$$R_B = (F_{O_s} - F_{O_{db}}) \times (V_x \times 10) / V_F$$

$$R_A = (F_{A_s} - F_{A_{db}}) \times (V_x \times 10) / V_F$$

where:

- $F_{O_s}$  = F - orig sample reading
- $F_{O_{db}}$  = F - orig dry blank reading
- $F_{A_s}$  = F - acid sample reading
- $F_{A_{db}}$  = F - acid dry blank reading
- $V_x$  = volume of acetone extract
- $V_F$  = filtered sample volume

## METHOD CAPABILITIES

Chlorophyll-a concentrations ranging from 0.1 to 50  $\mu\text{g L}^{-1}$  in the acetone extract (i.e., a 100 mL sample ranging in concentration between 0.01 to 5  $\mu\text{g L}^{-1}$ ) may be measured by this method without recalibration of the instrument. Detection capability for water samples with very low concentrations can be improved by increasing the volume of water filtered. Likewise, in high concentration samples, either smaller volumes may be filtered, or the extracted sample may be diluted.

## QUALITY CONTROL

QA/QC tests undertaken as part of the data reporting include:

### Assessment of the limit of detection

- The Limit of Detection (or detection limit) is the lowest concentration level that can be determined to be statistically different from a blank (99% confidence).
- Minimum detection limits were calculated for this method using repetition of blanks.
- The effective detection limit for a 100 mL sample is 0.1  $\mu\text{g L}^{-1}$ .

#### Assessment of accuracy of the analysis

- This is generally achieved by using reference materials to assess recovery of known amount of analyte.
- The Solid Secondary Standard (SSS) is run daily at the beginning and end of the sample run. For each sample set, an average of the readings as a percentage of the true value is used to determine accuracy.
- A yearly instrument calibration against a commercially available Chlorophyll-a standard is performed to ensure the accuracy of fluorometer readings and associated measurements (Appendix 1).

#### Assessment of precision of the analysis

- This is generally achieved by the repeated analysis of the same concentration of analyte to check for reproducibility.
- The coefficient of variance between repeated readings of the SSS at the beginning and end of an associated set of samples is calculated to assess precision.

#### Procedural blanks

- Filter blanks are run with every batch (generally daily). These are used as blank readings in the calculation of analytical results.
- Wet filter blanks are collected during sample collection to measure contamination of GF/F filters or through handling.

#### Reproducibility of duplicate analytical units

- The variation between results for sample duplicates indicates the reproducibility of the analysis and the effects of various sources of contamination and analytical error during collection, sample preparation and analysis. Before data analysis, duplicate samples are used to calculate the coefficient of variance (CV) for each sample. Duplicates with CV outside a pre-determined confidence range (20%) are marked for re-run analysis performed using duplicate spare samples.

#### Other

- Inter-calibration of this method with the HPLC method used by AIMS laboratories showed agreement of +/- %10.

- The linear range of this method was established utilizing increasing concentrations of primary standard. Samples are diluted if above this range.
- Calibrations cross-referenced by computer to analysis date.
- External calibration is run periodically or if SSS detects machine drift greater than 5%.

## APPENDICES

*All appendixes must be referenced within the body of the SOP*

#.1	Solid state standard adjustment, chlorophyll-a calibration, and door factor assessment
#.2	Chl cal worksheet template V2 example
#.3	Chlorophyll-a worksheet
#.4	Chlorophyll-a calculation template
#.5	Flow chart for chlorophyll-a analysis

## RECORDS

All AIMS analyses undertaken on behalf of AIMS or client must be recorded and stored as follows:

- Data must be lodged in a manner that complies with [External Document and Data Control Policy](#), [Data Access Policy](#) and AIMS Disaster Recovery Plan, and must have an associated metadata record (see for the Data Access Policy for full details).
- Raw experimental Measurement data must be stored as hard copy and digitally as specified by the External Document and Data Control Policy, and data from processing samples must be stored in the Data Centre with appropriate metadata (see this policy for other approved storage locations and requirements)
- The data custodian(s) is/are responsible for lodging the data and generating the metadata record.

## Appendix A9: Measuring total suspended solids in seawater

### AIMS-SOP-EFWQ-v2.0

#### Document Details

<b>Implementation date:</b>	15/05/2021	<b>Authorised by:</b>	Ulysse Bove
<b>Edition No:</b>	2.0	<b>Responsible Officer:</b>	Ulysse Bove
<b>Date of Issue:</b>	15/05/2021	<b>Review date:</b>	29/04/2024

#### TASKS INCLUDED IN THIS SOP

This method outlines the field and laboratory procedures for determination of the concentration of total suspended solids by gravimetry in a sample of seawater.

#### PRINCIPLE AND RESPONSIBILITIES

The method is based on gravimetrically determining the dry weight of particulate material collected from a known volume of water onto a pre-weighed membrane filter.

Unlike samples from freshwater environments, those collected in a marine environment may have high levels of dissolved salts that need to be either minimised or compensated for by accurate measurement of the weight of salts retained. This method utilises the first strategy through minimal interstitial retention by filter choice and rinsing. Polycarbonate filters are used (rather than glass fibre filters) to optimise the effects of rinsing and minimise interstitial capacity.

#### SIGNIFICANT HEALTH & SAFETY RISKS

Hazards	Risk	Control
Electrical	Electrical shock	Protect electronic components from water leaks/spills and clean up any spills immediately. Disconnect instrument before conducting maintenance or servicing. Call an electrician if you are not sure you can solve the problem safely.

#### PERSONNEL PREREQUISITES & COMPETENCIES

Laboratory safety induction  
 Read and understood procedure  
 Training by experimented technician

## TOOLS & EQUIPMENT

- 1 litre plastic bottle or jar
- Polycarbonate membrane filters - 0.4 µm pore size x 47 mm diameter (Nuclepore, Poretics, etc....)
- Clean 20 mL scintillation vials with caps
- Millipore forceps (2 pairs)
- Filter funnels (47 mm), filter supports, and clamps
- Vacuum manifold, water trap and pump
- Analytical balance (5 decimal places)
- 100 mL, 250 mL or 1 litre plastic graduated cylinder
- 60 mL sterile syringe and 0.2 µm syringe filter (Pall Acrodisc or similar)
- Drying oven set at 60°C
- Milli-Q water in squeeze bottle, ~30-60 mL needed per filter
- Fine-tip permanent labelling marker

## ENVIRONMENTAL CONSIDERATION

None as no reagents or preservatives are used during the sampling or measurement processes.

## CHEMICAL DISPOSAL

No chemicals are used the processing of samples.

## REFERENCES

Neukermans, G., K. Ruddick, H. Loisel and P. Roose, 2012: Optimization and quality control of suspended particulate matter concentration measurement using turbidity measurements; *Limnology and Oceanography: Methods* 10, 2012, pp1011-1023.

## PROCEDURE

### 1. CAPABILITIES AND LIMITS OF DETECTION

As with any gravimetric measurement the limiting factor for detection is often sampling technique, the homogeneity of a sample and the level of reproducibility that can be achieved when subsampling. Following a series of wet filter blank trials, it was concluded that the smallest amount of solid that can be confidently measured is 0.10 mg. Therefore, when one litre of seawater is filtered, the lower limit of detection is 0.10 mg L<sup>-1</sup>. The upper limit is dependent on particle load and size. Turbid water with a lot of fine material will block the filter prematurely, allowing only a small volume to be filtered. River water or sediment trap water samples with large concentrations of fine particles may clog the filter

after as little as 10 mL is filtered. Such small volumes will lead to a greater relative error due to small variations in the volume filtered and degree of homogeneity within the sample. Thus, this method is not suitable for turbid waters and is only appropriate in the coastal or open ocean.

Wet filter blanks are produced by following the same preparation steps as for the samples but using ~20 mL of 0.2 µm filtered seawater (typically filtered sample water is used). The average weight of these sets of blanks is subtracted from the final dry weight of sample to account for salts not washed out in the Milli-Q water rinse step. If no rinsing is done, then the salt retained in the filter can sometimes weigh as much as the sample dry weight. Polycarbonate filters are used not only because they are less hydroscopic than the traditionally used glass fibre filters (i.e., do not require a desiccator for storage) but also because minimal interstitial volume allows only minute traces of salt to be retained in a filter after rinsing. They also dry more easily, reducing drying times and the necessity for re-weighing to guarantee dryness as is necessary for glass fibre filters.

## **2. PREPARATION PRIOR TO FIELD WORK**

- Pre-label the lids of one or more trays (100) of clean, dry 20 mL scintillation vials with an alphanumeric sequence (e.g. JC100, JC101, JC102.....) using a fine tip marker pen.
- Using a 5-place analytical balance weigh a filter and transfer the weighed filter to a numbered vial without wrinkling or creasing the filter. (photo 1). Handle the filters only with the forceps.
- Make a record of the filter weight against the vial number (Appendix 1).
- Repeat for required number of filters.

## **3. SAMPLE COLLECTION AND HANDLING**

- Pictures and details of the following process are described in Appendix 3
- TSS bottles can be filled on site and then transported back to land in the dark on ice. TSS can be filtered within 24 hours of collection as long as it is kept refrigerated. This will inhibit the growth of microbes and the formation of colloidal masses that block the pores of the filter.
- Set the vacuum pump and manifold up using 47 mm filter funnels that are held in place with clamps. Check that the water trap is empty before beginning filtering.
- Take a pre-weighed polycarbonate membrane filter out of its scintillation vial using forceps. Place the filter on the filter support. Wet the filter with a small amount of Milli-Q water and place the filter funnel on top, securing with a clamp.
- Before beginning filtering, make sure to record the code written on the scintillation vial in the Field Datasheet (Appendix 2).

- Collect 1 litre sample of seawater in the 1 L plastic bottle. Before drawing off the sample to the bottle make sure that the sample is homogenous by thoroughly mixing/shaking the Niskin or collection vessel if it has been sitting undisturbed for >5 minutes. If the 1 L plastic bottle has been sitting >5 minutes, make sure to shake it well before beginning filtering so that all material is resuspended.
- Turn on the vacuum pump and up-end the 1 L bottle on top of the filter funnel. The neck of the bottle will stop water flowing over the top of the filter funnel as long as you don't disturb the bottle. Open the plastic tap on the manifold to begin filtering.
- If the water is very turbid (Secchi depth < 3 m) and it is unlikely that the full amount of sample will pass through the filter without clogging, it may be necessary to reduce the volume filtered. In this case, use a graduated cylinder to measure a smaller volume for filtering. Ensure you shake the sample well before pouring into the graduated cylinder and record the volume filtered on the Field Datasheet. It should take no longer than 20 minutes to filter a sample.
- After the sample has completely filtered through and the filter is sucked dry, wash down the sides of the funnel and rinse the filter with ~20 mL of Milli-Q water. Ensure that Milli-Q covers the entire filter surface (you may need to turn off the manifold tap temporarily to reduce suction to achieve this). Allow the filter to suck dry and repeat this rinse process two more times.
- Wait until all water has filtered through and turn the vacuum suction almost all the way off by using the plastic tap at the base of the filter funnel. Leaving the vacuum on very slightly helps to keep drying the filter while you remove it from the filter support. It also prevents water sitting in the manifold base from refluxing back onto the filter. Remove the filter funnel and gently lift one side of the filter with the forceps to break the vacuum. The filter should be perfectly dry with no moisture on it.
- Using forceps, fold the filter in half with the filtered material on the inside, then in quarters. The forceps should not touch the coloured central part of the filter, but only the clean outer rim. Return the folded filter to the numbered scintillation vial from which it came.
- Record the vial number, volume sampled and replicate number against the station name and depth on the Field Datasheet.
- The filtered samples can be stored at room temperature for short periods (1-2 days) if kept dry but avoid hot or humid storage areas as mould may become a problem. If possible, dry the filters at 60°C before extended storage. If conditions are humid and a drying oven is not available, store the filters in fridge or freezer.

#### 4. ANALYSIS

- Loosen the caps on the scintillation vials to allow some air transfer, but do not separate them from their vial. Dry for 72 hours at 60°C in a drying oven. After the filters are dry, re-tighten the caps on the vials and allow them to cool to room temperature.
- Re-weigh the dried filter on a 5-place analytical balance. Record the loaded filter weight (final weight) on the worksheet next to the initial filter weight (Appendix 1). If working at AIMS, use the filter weight system to record this information.

## 5. BLANKS

- A set of wet filter blanks should also be run with collection as part of the sample processing routine. This involves putting a filter on the filtering funnel and wetting with Milli-Q (this saturates the filter under the “lip” of the funnel, minimizing saltwater intrusion). Next, pour a small volume (~20 mL) of 0.2 µm filtered seawater into the filter funnel. Typically filtered sample water from the last sampling site of the day is used for this.
- After the sample has completely filtered through and the filter is sucked dry, wash down the sides of the funnel and rinse the filter with ~20 mL of Milli-Q water. Ensure that Milli-Q covers the entire filter surface (you may need to turn off the manifold tap temporarily to reduce suction to achieve this). Allow the filter to suck dry and repeat this rinse process two more times.
- This procedure combines both a transport and handling blank and corrects for the very small amount of salt left behind in and on the polycarbonate filter. A duplicate set of blanks should be taken with each collection trip. The average weight of all filter blanks for a given trip or subsequently a sampling year is then removed from the entire dataset to account for weight blank correction. Negative weights are considered to be 0 mg if the negative weight is less than 0.0001 mg.

## 6. CALCULATION

$$\text{Suspended Solids} = \frac{(\text{final weight} - \text{initial weight}) - \text{wfb}}{\text{Sample volume}}$$

Where:

initial weight = weight of unused filter (g)

final weight = weight of loaded filter (g)

wfb = weight of averaged duplicate wet filter blanks (g)

Sample volume = volume of sample filtered (litres)

Suspended solids = concentration (g L<sup>-1</sup>) of particulate matter in sample with a particle size greater than 0.4 µm.

## REPORTING

Results are generally reported in mg L<sup>-1</sup> for seawater. If this is the case, the following additional calculation will need to be made.

$$\text{Suspended Solids (mg)} = \text{Suspended Solids (g)} \times 1000.$$

## APPENDICES

*All appendixes must be referenced within the body of the SOP*

#.1	Example of log sheet for recording suspended solid filter weights
#.2	Example of field data sheet
#.3	Quick reference for filtering total suspended solids samples
#4	
#.	

## RECORDS

All AIMS analyses undertaken on behalf of AIMS or client must be recorded and stored as follows:

- Data must be lodged in a manner that complies with [External Document and Data Control Policy](#), [Data Access Policy](#) and AIMS Disaster Recovery Plan, and must have an associated metadata record (see for the Data Access Policy for full details).
- Raw experimental Measurement data must be stored as hard copy and digitally as specified by the External Document and Data Control Policy, and data from processing samples must be stored in the Data Centre with appropriate metadata (see this policy for other approved storage locations and requirements)
- The data custodian(s) is/are responsible for lodging the data and generating the metadata record.



## Appendix A10: AIMS In-house procedures for WET Labs FLNTUSB ECO logger

### 11.1 Set up WET Labs FLNTUSB ECO logger:

#### 11.1.1 Start ECOView and the logger

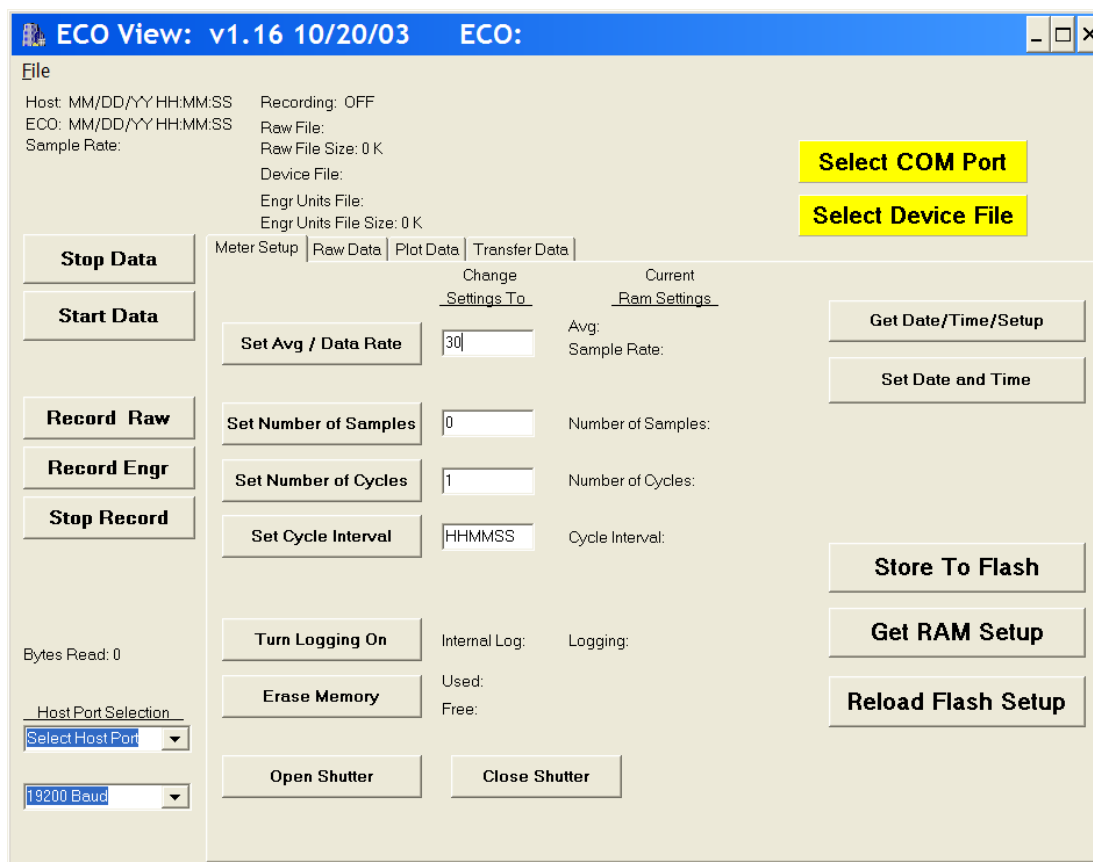
- Connect the battery leads on the test cable to the 12V battery (adaptation of the test cable by AIMS). Connect the DB-9 connector to a computer with the ECO View program installed.
- Start up the ECO View software:



- Click  and select appropriate port for the DB-9.
- Click  and browse for the most recent version of the device file (.dev) appropriate to the logger you are running.

The logger with serial number 818 requires device file FLNTUSB-818.dev. Device files are updated by WET Labs when the logger is returned the manufacturer for calibration and maintenance. (The device file is specific to the logger if creating output in 'Engineering units', but not for 'Raw' output. However, a device file must still be selected to create raw output.)

Note that ECO View cannot read files stored in folders containing spaces in the folder names, therefore do not store sub-folders in the 'My Documents' folder or others with spaces in the name.

- Connect the 6-socket connector on the test cable to the logger to provide power to the LEDs and electronics. Light should emanate from the optical window of the logger, the frequency determined by the setup. **Quickly** stop the logger (you can only stop the logger when the light is flashing during a reading, so if the logger is set to read at 10 minute intervals you have limited opportunities.)

**Stop Data**

- To stop logger, click **Stop Data** multiple times whilst the instrument is emanating light during the reading. The logger should stop running.

### 11.1.2 Check ECO View settings.

In 'Meter Setup' tab view, ensure the logger is setup to sample correctly during lab calibration.

- Click **Reload Flash Setup**
- Then **Get RAM Setup**

The 'Current Ram Settings' column of the parameter list is now updated with the current settings of the logger:

	Change Settings To	Current Ram Settings
<b>Set Avg / Data Rate</b>	<input type="text" value="30"/>	Average: 30 Sample Rate: 0.10 Hz
<b>Set Number of Samples</b>	<input type="text" value="0"/>	Number of Sample: 1
<b>Set Number of Cycles</b>	<input type="text" value="1"/>	Number of Cycles: 0
<b>Set Cycle Interval</b>	<input type="text" value="HHMMSS"/>	Cycle Interval: 00:00:10

If the logger was set for logging in the field, the settings will need to be altered for laboratory calibrations.

#### **Settings for laboratory calibration checks:**

- Enter '50' as Avg / Data Rate.

**Set Avg / Data Rate**

Then click 'Set Avg / Data Rate' button to set.

- Enter '1' as Number of Samples.

**Set Number of Samples**

Then click 'Set Number of Samples' button to set.

- Enter '0' as the Number of Cycles.

**Set Number of Cycles**

Then click 'Set Number of Cycles'

button to set.

- Enter '000005' as the Cycle Interval.

  Then click 'Set Cycle Interval' button to set. (Samples every 5 seconds.)

The instrument will average 50 samples, for one reading, once every 5 seconds; beginning on power-up.

### **Settings for field logging:**

- Enter '50' as Avg / Data Rate.

  Then click 'Set Number of Samples' button to set.

- Enter '1' as Number of Samples.

  Then click 'Set Number of Samples' button to set.

- Enter '0' as the Number of Cycles.

  Then click 'Set Number of Cycles' button to set.

- Enter '000957' as the Cycle Interval.

  Then click 'Set Cycle Interval' button to set. (Records every 10 minutes.)

- Alternatively, you may need to enter '000958' in older instrument versions.

- **IMPORTANT: Turn logging on,** click  so that the data is stored in the logger memory.

The instrument will average 50 samples, for one reading, recording every 10 minutes; beginning on power-up.

Set Avg/Data Rate = 50                      Average 50 Samples for one measurement  
Set Number of Samples = 1    Take 1 Measurement (takes 2 seconds)  
Set Number of Cycles = 0    Cycle continuously

Set Time Interval = 000957                      (HHMMSS) 9 minutes 57 sec per cycle.

### **Commit logger settings:**

To commit the above settings to the logger, click



- When settings committed, the yellow warning symbol **Setup Not Stored** should disappear from the top right hand corner of the screen.
- To ensure flash storage, first click **Reload Flash Setup**
- Then click **Get RAM Setup** and check that 'Current RAM settings' have been changed to the correct values.
- To align time on logger with time on laptop click **Set Date and Time** (This will not work if the instrument is currently logging.)

## 11.2 AIMS Laboratory calibration checks

To determine instrument drift between field deployments, several checks can be performed.

1. Dark counts (in fresh water)
2. Determination of maximum fluorescence (in air)
3. In-house turbidity and chlorophyll calibration checks (*in situ* in seawater, co-deployment from AIMS pontoon)
4. In-house temperature calibrations (in calibration bath).

The settings used for the checks 1 and 2 are as per Section 11.1.2 'Settings for laboratory calibration'. Field sampling and AIMS pontoon co-deployment readings occur every 10 minutes which is too infrequent for laboratory tests.

### 11.2.1 Dark counts

#### *Pre-logging preparation*

The 'dark cap' is used for dark counts performed as a comparison to WET Labs factory calibration dark counts and therefore carried out as in WET Labs servicing laboratory. The external battery source is used and the bio-wiper is removed.

- Setup logger as per Section 11.1 and settings as per Section 11.1.2 'Settings for laboratory calibration'
- Stop the logger if it is running.
- Remove the bio-wiper.

Remove the bio-wiper. **IMPORTANT** the logger must not be running when you do this. **Note, manually turning the motor shaft can damage the wiper motor and void the warranty.**

- Apply black electrical insulation tape to cover the optical window.
- Fill large plastic beaker with water and immerse the 'back cap'.
- Insert the optical head of the logger into the 'black cap' immersed in water.

AIMS Water Quality group standard height of the logger collar is positioned 6cm from the optical end of the logger, which locates the logger at a suitable standard height within the calibration cap. (The height is not relevant for dark counts, but it is for protection of the bio-wiper in transit to the field.)

## Logging

Run logger in ambient light.

- Click **Start Data**
- View 'Plot data' menu tab:

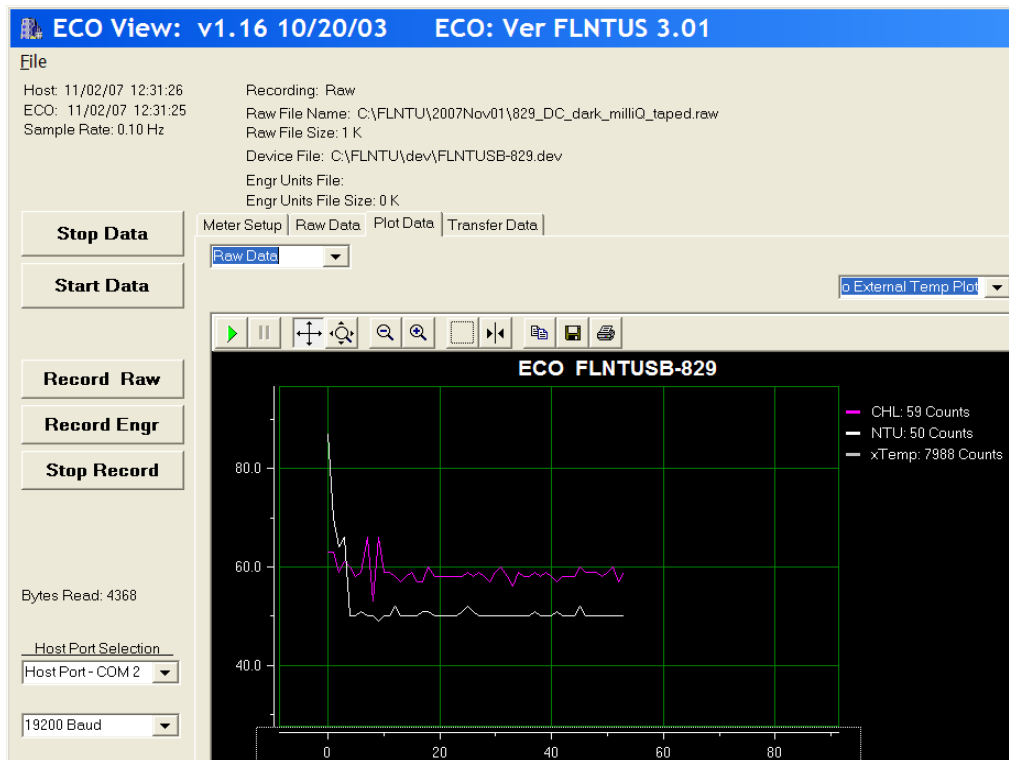

- Once plot has settled to consistent readings, click **Record Raw**
- Browse to the appropriate folder to store the .raw file, and 'save'.
- Record this start time on the data sheet.
- File name convention: 829\_DC\_2007Dec06.raw I.e.. Logger 829, Dark Count, year, month, day.
- Continue logging for 5 minutes to obtain ample readings to calculate a minimum dark count.
- Stop logging, click **Stop Record**. Then click **Stop Data** multiple times whilst the instrument is emanating light during the next reading. The logger should stop running.
- Record this end time on the data sheet.
- Remove the logger from the calibration cylinder and remove the black tape from the optical port.
- Unplug the logger.

Your raw data file can be found in the folder you specified.

### 11.2.2 Determination of maximum fluorescence.

WET Labs provides a pink fluorescence stick as one of the 'spare parts'. This can be used to check whether the maximum fluorescence output is reading the same as the output specified in the FLNTU Characterization Sheet for each logger.

#### *Pre-logging preparation*

To measure maximum fluorescence the external battery source is used, and the bio-wiper is removed.

- Setup logger as per Section 11.1 and settings as per Section 11.1.2 'Settings for laboratory calibration'
- Stop the logger if it is running.
- Remove the bio-wiper.

Remove the bio-wiper. IMPORTANT the logger must not be running when you do this. **Note, manually turning the motor shaft can damage the wiper motor and void the warranty.**

#### *Logging*

Run the logger in ambient light.

- Click  **Start Data**
- View 'Raw data' menu tab:

**ECO View: v1.16 10/20/03 ECO:**

**File**

Host: 12/06/07 11:27:10      Recording: OFF  
 ECO: 12/06/07 11:27:11      Raw File:  
 Sample Rate: 0.10 Hz      Raw File Size: 0 K  
                                  Device File: C:\FLNTUSB\_loggers\_Izlaptop\dev\FLNTUSB-829.dev  
                                  Engr Units File:  
                                  Engr Units File Size: 0 K

**Stop Data**      Meter Setup   Raw Data   Plot Data   Transfer Data

**Start Data**

**Record Raw**

**Record Engr**

**Stop Record**

mvs 1						
12/06/07 11:26:16	695	62	700	54	8936	
mvs 0						
mvs 1						
12/06/07 11:26:27	695	62	700	56	8935	
mvs 0						
mvs 1						
12/06/07 11:26:38	695	4120	700	4120	8827	
mvs 0						
mvs 1						
12/06/07 11:26:49	695	4120	700	4120	8826	
mvs 0						
mvs 1						
12/06/07 11:27:00	695	4120	700	4120	8825	
mvs 0						
mvs 1						
12/06/07 11:27:11	695	4120	700	4120	8825	
mvs 0						

Bytes Read: 328

- Hold the fluorescent stick approx. 1 cm from the optical port, in the air parallel to the logger optics as per the Wet Labs information sheet.

When it is apparent that the position of the stick is suitable (by reading maximum counts on the Raw data' window in 4<sup>th</sup> column)

- Click **Record Raw**

Example above indicates maximum output for chlorophyll signal 4120 counts.

- Browse to the appropriate folder to store the .raw file, and 'save'.
- File name convention: 829\_fluor\_2007Dec06.raw, i.e. Logger 829, Fluorescence determination, year, month, day.
- Record three maximum output readings to compare with FLNTUSB Characterization Sheet. Enter maximum value on data sheet.

- Stop logger, click **Stop Record**, then click **Stop Data** multiple times whilst the instrument is emanating light during the next reading. The logger should stop running.
- Unplug the logger.

Your raw data file can be found in the folder you specified.

### 11.2.3 AIMS In-house 'Pontoon' turbidity and chlorophyll calibration checks

To test the logger data output against laboratory analyses, as well as to compare logger output relative to each other, AIMS has adopted a co-deployment of loggers in addition to laboratory checks. Results from AIMS Pontoon deployments provided to WET Labs initiated a new calibration procedure in their factory.

- All available ECO loggers are co-deployed for a 2–3 day period prior to servicing and between redeployment cruises
- they are placed in a rack and hung in coastal seawater off the AIMS Pontoon
- they are set to log in 'field mode' with readings at the same times, every ten minutes

During this period the loggers are exposed to varied turbidity and chlorophyll levels, due to the tides and relatively high turbidity of the location of the pontoon.

- Water samples are collected to coincide with the logger readings, (3–6 times per day) at the same 10 minute intervals that the loggers are set to record
- Water samples are collected adjacent to the logger rack with weighted bottle holders which have acid washed bottles inserted and suspended by stainless cable
- The water samples are filtered immediately after collection, in the AIMS laboratory
- These water samples are filtered and analysed for Chl-*a* and TSS following the same procedures as AIMS MMP field sampling.
- 2 replicate Chl-*a* samples are collected at each time
- 2 replicate TSS samples are collected at each time
- The water sample collection times, volumes filtered, filter numbers are recorded and entered into the Oracle database using the same procedures as the AIMS field water sampling
- The logger data is downloaded following deployment as per field deployment procedures
- The data records from the loggers are loaded into the database with the site name 'AIMS' and the filter samples collected identified with the 'ECO' sample i.d. code to distinguish them from field cruise samples
- The logger data is plotted together to determine differences between loggers, and against the laboratory samples how they sit within the range of the laboratory analyses



The logger rack was built by the AIMS workshop, specifically for the purpose of co-deployment. The loggers are in close proximity and effectively measure the same water body.

#### 11.2.4 AIMS in-house temperature calibrations

AIMS has a high precision temperature calibration facility and thus performs reliable temperature calibrations on loggers starting in early 2015.

##### Setting up the temperature bath for calibration

- Plug the sensor measurement module into the temperature reference thermometer
- Turn on the temperature reference thermometer by turning on the green switch on the face of the reference measurement module
- Place the sensor measurement module of the temperature reference thermometer into the water bath using the clamp.
- Remove a small amount of water using a bucket and mix hot water from the tap into the bath to raise the temperature to approximately 33°C
- Ensure the water level is within 2–3cm of the lip of the bath
- Turn on the temperature bath
- Set the bath set point to 33°C as follows:

Press the SETPNT key

Enter 33.00

Press <Enter>

- Wait until the set point is achieved and holding steady in the bath.

## Setting up the Temperature Bath Calibration Tool for calibration

- Turn on the PC attached to the temperature reference thermometer and log in.
- Start Temperature Bath Calibration Tool on the desktop
- Choose a file location for temperature cycle calibration. Name the file with a .txt extension. The file will be created by the software. e.g. 20160319-FLNTUSB.txt
  - Sample Interval 1 Minutes
  - Setpoint Duration 1 Hour
  - Start Setpoint 33 Degrees
  - End Setpoint 16 Degrees
  - Setpoint change 1 Degree

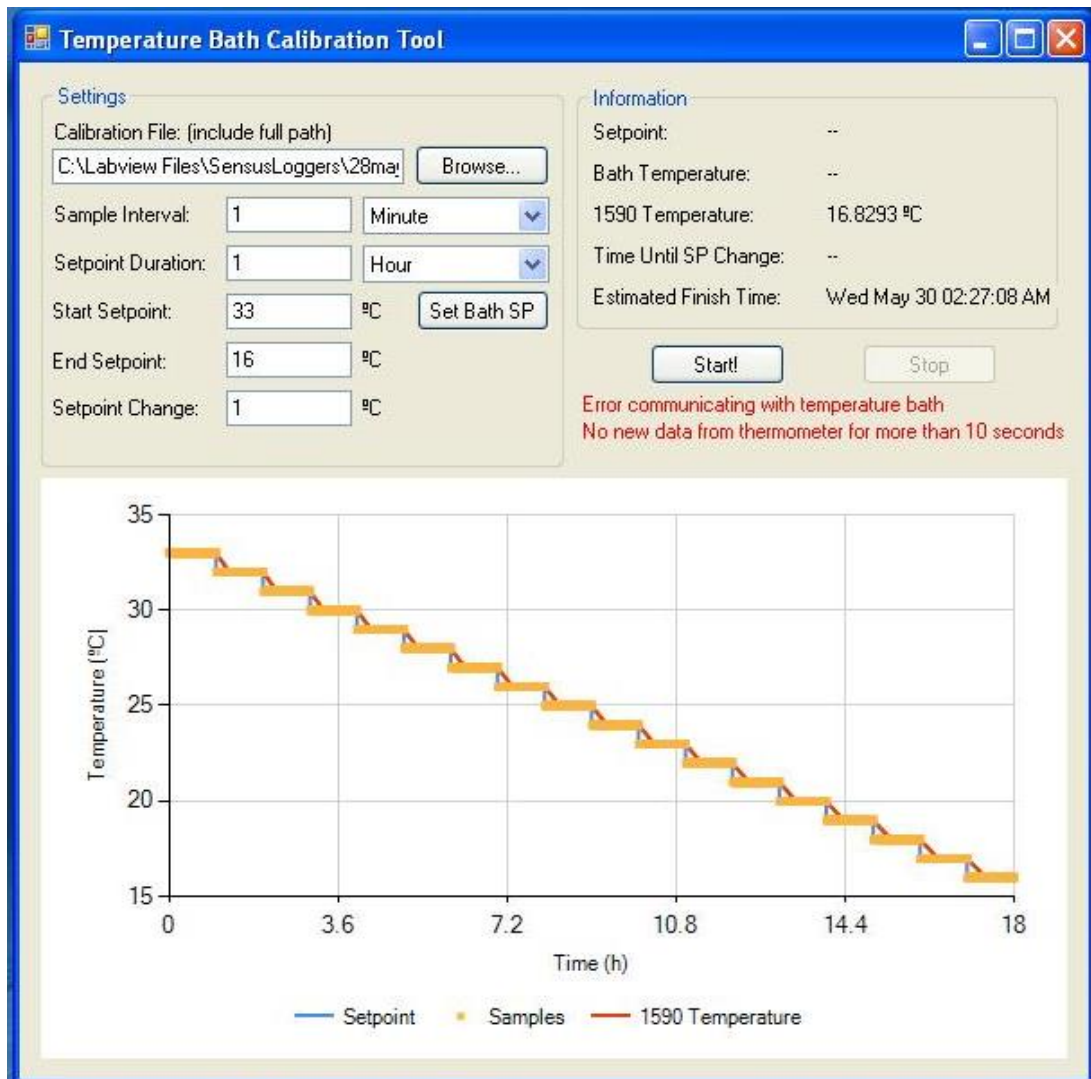

Note: the above image was taken after the bath had finished the calibration from 33 to 16 degrees

## Running the calibration

- Run essential.exe in C:\temp This program mimics keystrokes on your pc to stop it

hibernating.

- Start the calibration on the 30 second mark of the minute. (this is to assist in the data management of the calibration data.)
- To start the calibration, simultaneously plunge the sensors into the calibration bath and press the Start! button. The calibration will now be underway.
- The calibration should take approximately 18 hours to complete. Once it has finished:
  - \*\*Remove the loggers from the water
  - \*\*Create a folder with the datestamp in \\pearl\temp\FLNTU
  - \*\*Save the calibration file created by the Calibration Tool in the folder above.

### Calculating the temperature calibration slope and intercept

- Use the STDMS Sea Temperature Data Management System (STDMS)
- Put a valid folder in “working directory” E.g. C:\underway\Calibration
- Press “set up folders”

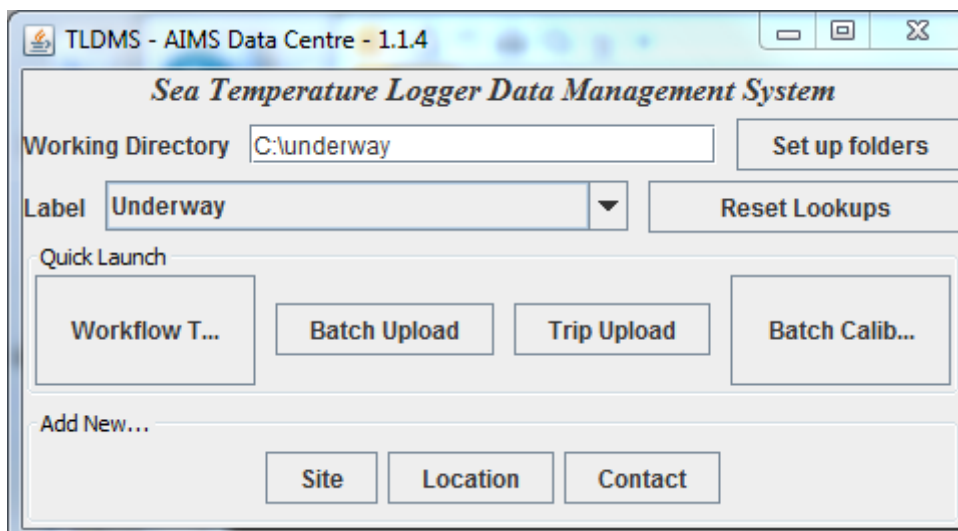

- Copy your data files to a sub-folder of <working directory>/calibration/cals
- E.g. C:\underway\Calibration\Cals
- Press the button “batch calibration”
- Use the “...” buttons to choose a folder and a reference file

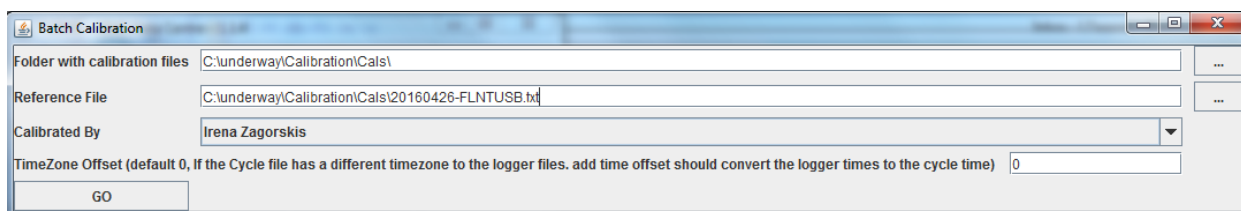

- Press the “GO” button.
- Find your calibration files in the “cals” subdirectory of the data directory.
- E.g. C:\underway\Calibration\Cals\cals

Example calibration file output:

Sea Temperature Data Logger Calibration File for a Sensus Logger Calibration	
Logger serial number	818
Logger Type	flntu
Calibration Date	26/04/2016
Linear Regression Calibration Coefficients	
equation:	$y = \text{Slope} \cdot (x) + \text{Offset}$
Slope	-0.005564551
Offset	71.29684193
RSquared	0.999846376
Anova SSE	0.741959946

## 11.4 Field deployment of ECO logger

### 11.4.1 Final logger preparation for deployment

The final preparation of the logger for deployment includes:

- The 6-pin dummy plug must be connected.
- Apply insulation tape to parts of the instrument to be taped with copper tape. This protects the logger casing from the significant adhesive residue of the copper foil tape.
- Subsequently copper tape (3M 1194 copper foil with non-conductive adhesive) is applied to the outer casing of the instrument adjacent to the faceplate.
- Connect the 3-pin power plug (identified by red or orange tape). This turns on the internal battery. N.B. For autonomous operation, the 'power plug' must be connected to the 3-pin bulkhead connector. This 'jumper' shorts pins 1 and 3, connecting the internal battery supply to the logger.
- Record the connection time on the deployment datasheet.
- Ensure the lock collars of the dummy and power plugs are screwed firmly.
- Check the vent seal plug for full insertion.
- Wrap the remainder of the exposed logger casing and plugs with plastic (we use cut up garbage bags) and secure firmly with insulation tape.
- Wrap tape over most of the logger deployment clamp to protect from fouling.
- Attach plastic AIMS identification label to clamp with cable tie.
- Attach the logger clamp to the logger, securing firmly with the Allen key.
- Ten minutes after the logger was turned on, check the bio-wiper and logger function and ensure it is running (the logger is set to read at 10-minute intervals for field deployments).
- Protect the logger face with the field deployment black cap, to ensure the bio-wiper is not touched.
- Place the logger in the padded case.

### 11.4.2 Deployment equipment list

When loading the work boat the following gear is required:

- Logger (in protective padded case)
- SCUBA gear including dive watch
- Dive log sheet and pencil
- GPS (with dive site loaded)
- Marker buoy with rope and chain weight attached
- Niskin bottles x 1
- Large rubber bands to secure Niskin closed during handling back onto boat
- Spanner to attach logger clamp to star picket (plus a spare)
- Safety gear according to AIMS Field Work Procedures.

### 11.4.3 Logger deployment and recovery dive

The logger site is located by GPS and the marker buoy deployed to mark the site. The work boat is anchored up close to the site, typically up-current but mindful the anchor should not be dropped near the underwater benthic survey transect lines.

Once the divers are kitted up to dive, they enter the water and the boatperson passes 1 Niskin (filling with surface water to allow the Niskins to sink) and the logger to the divers on the surface. Care is taken that the bio-wiper of the logger does not contact anything, to ensure it is not disabled. The divers proceed down the buoy line and locate the logger star picket.

The divers are careful not to disturb the bottom sediment or disturb fouling on the star picket until the 'ground truth' water sample is collected. The Niskin is used to sample the water immediately adjacent to the logger. Both ends of the Niskin bottle are opened, and the diver swings the Niskin through the water to ensure the Niskin water is flushed, and the water representing that adjacent to the logger is contained in the Niskin. This Niskin is closed and placed gently on the substrate until logger changeover complete. The depth of the water sample is checked on the SCUBA depth gauge.

The new logger to be deployed is placed gently on the substrate with the bio-wiper clear from obstruction. The diver uses the spanner to detach the clamp of the logger to be recovered from the star picket. It may be necessary to remove fouling such as barnacles, hydroids and algae from the star picket. The face of the logger is inspected to assess whether it is still functioning, and the recovered logger placed gently on the substrate whilst the new logger and clamp attached to the star picket.

The loggers are mounted with the optical window facing downward, so that the infrared LED source will not 'see' any part of the deployment hardware. A final function check of the newly deployed logger is done by checking that the bio-wiper turns and the logger samples underwater after the appropriate 10-minute time interval. See photo of deployed logger below.

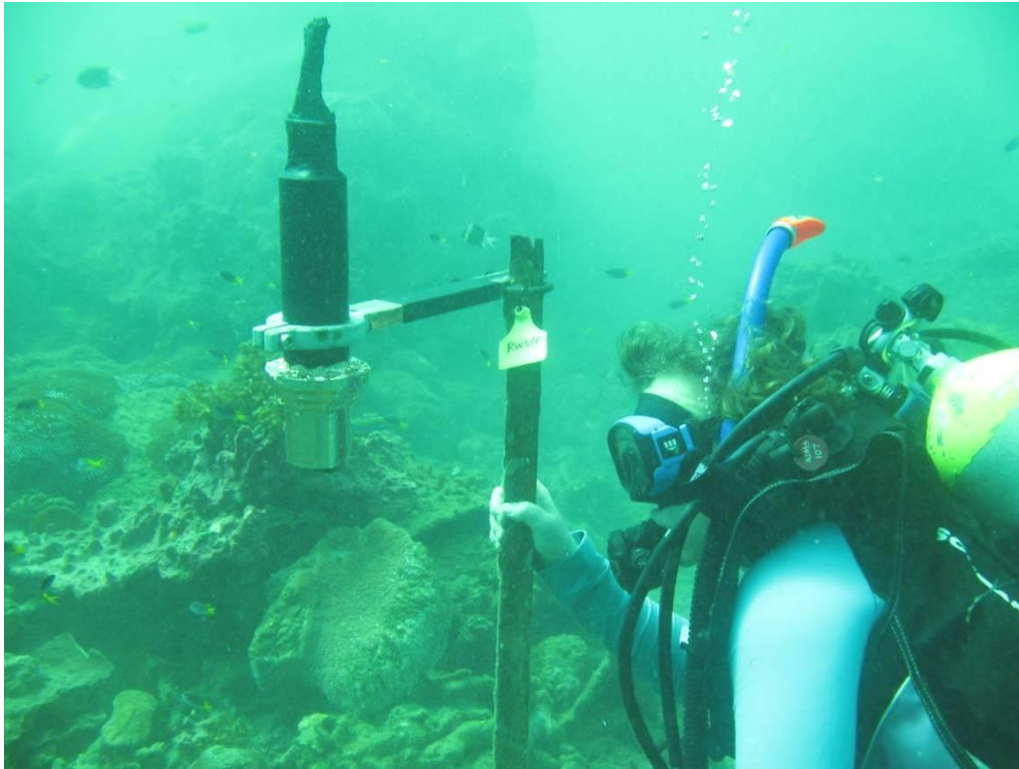

The divers return to the work boat with the recovered logger, and Niskin bottle. The boatperson carefully collects these from the divers at the surface. The field deployment black cap pre-filled with seawater and the logger placed upright with the logger face immersed in the seawater.

AIMS Water Quality group standard height of the logger collar is positioned 6 cm from the optical end of the logger, which locates the logger at a suitable standard height within the black cap used for field deployment. This protects the bio-wiper from being bumped and contains seawater to allow the logger optical face to be protected until the logger can be switched off. Do not fill cap with fresh water, as this appears to react with the corrosion on the recovered logger and may cause damage to the optical window, if the bio-wiper is operating.

The 5 L Niskin is clamped shut using No.109 rubber bands used to ensure the sample water is not lost until placed in the Niskin rack on board the boat.

The Niskin seawater samples are processed without delay as per shipboard filtering procedures for Chl-a and TSS, and salinity sample is collected.

#### **11.4.4 Post recovery logger handling on board boat**

Once the logger is on board the boat, the logger is switched off as soon as possible. To do this:

- The face of the logger should remain immersed in seawater in the cap, with the top (connector end) of the logger out of water.
- Using a Stanley knife, cut the protective tape and plastic from the connector end of the logger to expose the connectors and plugs.
- Dry the connector end and remove the 3-pin power plug (identified by red or orange tape, or the newest plugs now have blue ends).

- Replace this with the 3-pin dummy plug (identified by green tape).
- Record the time the logger is switched off on the logger recovery datasheet

Once there is time available, following processing of the water samples, other tasks with the recovered logger include:

- Photograph the logger to show the degree of fouling on the instrument. (Example photo below showing fouling on a recovered logger).
- Carefully remove the plastic and tape from the logger casing.
- Rinse the logger clean with fresh water (now that the bio-wiper is no longer functioning because the logger is switched off). Allow to dry.
- Take further macro photographs to record the condition of the faceplate, bio-wiper and optical window of the logger.

Once there is time available, following processing

- Remove the bio-wiper carefully with the Allen key.
- Download the data and complete details in the logger download datasheet including a function check of the shutter
- When the data download is complete, the rinsed and dry logger should be returned to a padded Pelican case for return to the laboratory.
- Details of the dive time and depth should be transferred from the dive log sheet to the logger recovery datasheet.





## 11.5 ECO logger data download and storage

### 11.5.1 Data retrieval from ECO logger

Data is downloaded from the logger using the ECO View software on the computer.

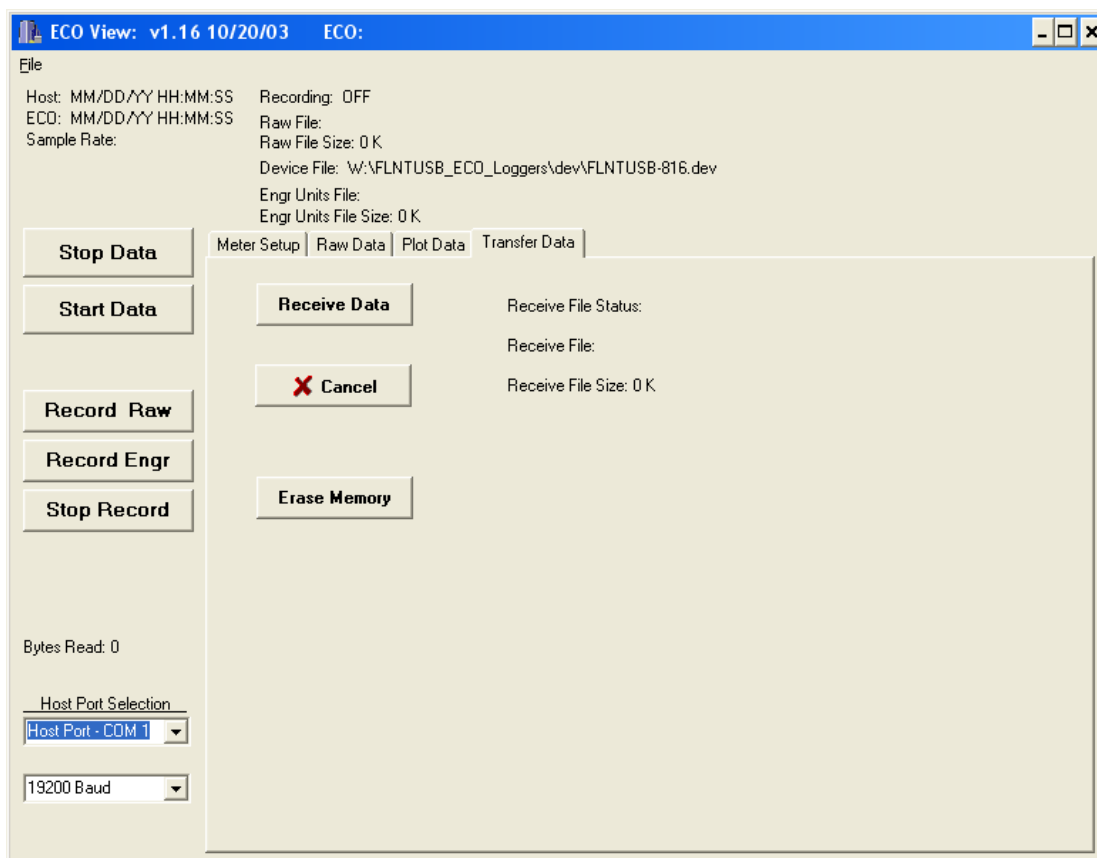
- Connect the logger to the computer and software package.
- View 'transfer data' menu tab:



- Click  and the file naming window will appear.
- Browse to the appropriate folder and name the raw data file.
- File name convention: 817\_reef\_2014Sep22\_Dunk.raw [i.e., Logger 817, reef deployment, year, month, day (**RECOVERY** date), site name].

A typical logger field deployment download may take about 10 minutes with a file size of 700–800 kb for a 4-month deployment. The 'Receive File Status' will indicate 'Complete'.

- Fill in details on the logger download datasheet
- Disconnect the logger from the computer connection cable and reconnect the 6-pin dummy plug.

## 11.5.2 Upload raw and QA/QC files to AIMS Data Centre Water Quality Environmental Logger Data Management System

The raw field data files are uploaded into the AIMS Data Centre Water Quality Environmental Logger Data Management System (ELDMS) and is discussed in more detail in Section A12.

The ELDMS currently has the structure as in the following screen view:

### Environmental Logger Data Management

[List Loggers](#)  
[List Logger Event History](#)  
[List Calibrations](#)  
[List Locations](#)  
[List Deployments](#)  
[Location Data Exports](#)  
[Location Data Charts](#)

Information about the loggers and the deployment locations (example screen shots below) is held in this database as well as the device calibration files and logger data files.

#### Deployment List

Restrict by Location:  AND/OR Logger:

Order By:

27 Deployments found, displaying 20 Deployments, from 1 to 20. Page 1 / 2.

Actions	Location	Logger Serial#	Deploy Date	Deploy Trip	Deploy WQ Station Name	Retrieval Date	Retrieval Trip	Retrieval WQ Station Name	Status	Raw File Uploaded	QA File Uploaded	Version Tag
<input type="button" value="View"/> <input type="button" value="QA"/> <input type="button" value="Delete"/>	Dunk	824.01	21/02/2015 14:50	6162	WQP068	No Date Available	0		C	No	No	UR
<input type="button" value="View"/> <input type="button" value="QA"/> <input type="button" value="Delete"/>	Dunk	843.0	22/09/2014 08:50	6069	WQP022	21/02/2015 14:50	6162	WQP068	C	Yes	Yes	UR

#### View Deployment

Deployment Id: 23284  
 Logger Serial#: 843.0  
 Location: Dunk  
 Sample Date: 22/09/2014 08:50

In-Situ WQ Stations:

Comments on Deployment:

#### Logger Deployment Details

Deploy Date: 22/09/2014 08:50  
 Deploy Trip: 6069  
 Deploy WqStationName: WQP022

#### Logger Retrieval Details

Return Date: 21/02/2015 14:50  
 Return Trip: 6162  
 Return WqStationName: WQP068

#### Data and QA Details

Calibration File Name: FLNTUSB-843\_comb-2014May8.pdf  
 Calibration Date: 08/05/2014 00:00  
 RAW Filename: 843\_reef\_2015Feb21-Dunk.raw  
 QA Filename: QA\_Edit1\_Dunk\_2014\_09\_22-08\_50\_843.0.xml  
 Status: C  
 Version Tag: UR

### **Upload raw data file to the ELDMS**

- Login to the ELDMS.
- Click 'List Deployments'.
- Select site by 'Restrict by Location' and/or Logger to be uploaded.
- Select 'QA' Action for the chosen deployment.
- Click 'Upload Raw Data File'.
- Browse for raw file, then 'Upload'
- Click 'Create Raw Data Records' which will automatically calculate 'engineering' units.
- The record processing will indicate it is 'running in the background' until the process is complete, and then a 'pop-up' window will confirm this.

[Back to Deployment View](#) [Back to Deployment List](#)

#### **Deployment 23284 Data QA**

Location: Dunk, Deployed Date: 22/09/2014 08:50, Retrieval Date: 21/02/2015 14:50, Logger Serial: 843.0

#### **Process Raw Data**

Upload Raw Data File:  [Browse...](#) [Upload](#)

Raw Data Filename: 843\_reef\_2015Feb21-Dunk.raw

[Create Raw Data Records](#) [Calculate Engineering Units](#)

#### **Manual Data QA**

Export XML Schema:  [Export XML Data File For QA](#)

Upload QA Data File:  [Browse...](#) [Upload](#)

QA Data Filename: QA\_Edit1\_Dunk\_2014\_09\_22-08\_50\_843.0.xml

Import XML Schema:  [Update Data From QA Data File](#)

- Click 'Export XML File for QA'

The logger data files are stored on the AIMS network Water Quality share area.

Once edits using WISKI-TV have been performed the QA/QC edited files are re-imported to the ELDMS.

### **Upload QA/QC XML files to the ELDMS**

- Login to the ELDMS.
- Click 'List Deployments'.
- Select site by 'Restrict by Location' and/or Logger to be uploaded.
- Select 'QA' Action for the chosen deployment.
- Click 'Upload QA Data File'.

#### **11.5.3 WISKI-TV ECO logger data quality control**

Sub folders on the AIMS network Water Quality share area contain the XML files in two main stages of the QA edit process. The folders and example file names are listed in the table below.

The XML file exported from the Data Centre ELDMS is saved to the folder  
1QA\_export\_xml

The files exported are stored into folders ordered by their file type, deployment location and **DEPLOYMENT date** and time, ending with the logger serial number.

N.B. Raw logger field deployment data files are named with the **recovery** date to avoid errors, but the exported files from the ELDMS are named with the convention including the **deployment** date.

The next step is the QA WISKI-TV editing process.

- Original exported files are left untouched as reference in 1QA\_export\_xml (with the file name convention format as per table below).
- Using Windows Explorer, copies made to folder 2QA\_edit1\_xml (using the file name convention as per table below).
- Using WISKI-TV the first edit (edit1) we delete start and end records of the logger when the logger was not in the water or when the logger had a physical malfunction. The information supplied on the logger deployment and logger recovery datasheets is used in the first edit.
- Once WISKI-TV QA/QC editing is complete, the XML files are re-imported to the AIMS Data Centre ELDMS and final individual point edits may occur in Oracle via the ELDMS.

## 11.6 References

WET Labs Combination Fluorometer and Turbidity Sensor ECO FLNTU User's Guide. Revision Y, 12 November 2008. WET Labs Inc., Philomath, OR, USA [www.wetlabs.com](http://www.wetlabs.com)

WET Labs ECO View Host Software for ECO Meters User's Guide. Revision I, 18 March 2008. WET Labs Inc., Philomath, OR, USA [www.wetlabs.com](http://www.wetlabs.com)

Anderson, C.W., 2005, Turbidity (version 2.1): U.S. Geological Survey Techniques of Water-Resources Investigations, book 9, chap. A6., section 6.7, July, accessed November 2007 from <http://pubs.water.usgs.gov/twri9A6/>

## **Appendix A11: AIMS Data Management Procedures for the Marine Monitoring Program**

### **12.1 Introduction**

Data Management practices are a major contributor to the overall quality of the data collected; poor data management can lead to errors, lost data, and can reduce confidence in the data. This appendix details the overall approach AIMS takes to develop data management practices that actively protect and enhance the quality of the data collected as part of the MMP.

### **12.2 Basic principles**

The fundamental goal is to ensure that at each step where data is transformed, modified or 'handled' the process is understood, documented and that there is a clear logical connection between the raw data coming into the system and the final processed data. It should always be possible to back-track from the final processed data to the raw data from the instrument or data sheet.

The MMP data management system centrally stores all the generated data in an integrated data system designed to allow cross-referencing and access to related data. The data are described in a metadata system and can be queried to access the data, both internally to AIMS as well as externally.

### **12.3 Data storage**

All data are stored in AIMS' centralised Oracle 9i database. This is located on a secured central UNIX server which is protected by a UPS power supply and fire suppression systems. The Oracle database operates in a 'zero data loss' mode with the following backups:

- Nightly backups to tape via Export of the main database.
- Mid-day 'hot-backup' to disk using Oracles backup utility.
- Log files are stored on a separate server allowing for complete roll-back and roll-forward of data to the database.

The backup tapes are stored off site (initially at the AIMS Marine operations building and then at the Recall service in Townsville) and a Disaster Recovery disk facility is being set up at James Cook University for remote storage of on-line backups.

### **12.4 Metadata**

Metadata are a critical part of the data record and must be stored, related to any data they represent, and discoverable as part of a robust data management practice. In the case of the MMP, metadata include: location information and date/time of sample collection; weather and sea state conditions during collection; volumes of water sampled or filtered; equipment and vessels used to collect samples; personnel involved in sample collection; sample identification codes; and laboratory methods used to process samples. Metadata related to sample collection are recorded on a Field Datasheet each time field sampling occurs. These records are entered into a centralised database (see below) and are also retained in hard copy. Metadata related to laboratory processing is recorded in analytical reports, which are entered into a centralised database and raw reports are saved on AIMS' internal servers.

## 12.5 Data management of biogeochemical data

Entry of data must be captured in a process that does its utmost to eliminate error as manual entry of data can be a major source of error in data collection. For this reason, various specific data management applications for the MMP have been developed at AIMS. These are:

- The Field Data Entry System (FDES)
- The Filter Weight Management Web Application, and a
- The Water Quality Data Management System which provides a web-based portal to ingest analytical results into the Oracle database.

The **Field Data Entry System (FDES)** is an implementation of a Microsoft Access Database which has two main components. A database schema that models the data collection process to provide data integrity, and a set of forms that control the data entry process by providing drop down selection lists, radio buttons of predefined selection options. This document will not provide in-depth details on the schema or form design. The FDES is integrated with a labelling system for the samples taken, allowing unique and traceable labels to be printed prior to going in the field. The label format includes the Station Name, a 6-digit alphanumeric code (e.g., WQQ001), which is unique to location and time, allowing all samples to be traced back to their original sampling event. Label information also includes the depth and duplicate number of the sample taken. Following sample collection, all information from the Field Datasheet is entered into FDES, checked, and then imported into the centralised Oracle database.

The **Filter Weight Management Web Application** is a J2EE based application that is accessed via any browser within the AIMS internal network. Using a set of forms with drop pre-defined selection lists, data entry error is kept to a minimum. The software forming the application's backend is integrated with the five decimal place precision weight scales and an Oracle database dedicated to storing filter weights. The integration with the scales is such that when the weight is finalised on the scales, that value is automatically placed in the web applications form for the particular weight with no manual weight entry required. For every filter, an initial weight is taken before the sampling, and a final weight is taken after sampling; both weights are performed in the laboratory using the same scales and Web Application.

The **Water Quality Data Management System** is a web-based portal that can be accessed via any browser within the AIMS internal network by a select group of MMP staff. Data entry

error minimised by not allowing manual data entry. The process for data entry for the analytical results into Oracle is through a file import task using pre-formatted Sample Results Feeder Sheets. The Web Application is integrated with a dedicated Oracle database (the AIMS Nutrients Database). The Nutrients database schema is complex and ties in with an AIMS workflow schema for tracking and recording when particular database manipulation actions take place. This document does not cover in-depth design of this database. The Sample Results Feeder Sheets are a pre-formatted Excel spreadsheet that are created by the Data Management System. Analytical results for all water quality parameters are then placed in these sheets and ingested into Oracle via this system. The System logs each time data are ingested, keeping a record of all changes to the database. Every time data are ingested, a copy of the Feeder Sheet is stored in the Nutrients Database.

## **12.1 Coral monitoring data management**

All field data is recorded on pre-printed datasheets. The use of standard data sheets aids in ensuring standard recording of attributes, and ensures required data are collected.

Upon return from the field, all data is entered on the same day into database forms linked directly to an Oracle Lite database. Each field on these forms mirror those on pre-printed data sheets and include lookup fields to ensure data entered is of appropriate structure or within predetermined limits. For example, entry of genera to the demography data table must match a pre-determined list of coral genera.

Upon return to the office, the data is uploaded to an Oracle Database using the Oracle Lite synchronization process. All keyed data is printed and checked against field data sheets prior to final logical checking (ensuring all expected fields are included and tally with number of surveys). The Oracle database is backed up on a daily basis. Photo images are burnt to DVD prior to analysis this copy to DVD doubles as a backup of the photo images. Photo images are stored on a server that is included in a routine automatic back up schedule.

Image analysis is performed within the AIMS monitoring data entry package "reefmon". This software contains logical checks to all keyed data and is directly linked to a database to ensure data integrity. The directory path to transect images is recorded in the data base. This functionality allows the checking of benthic category identification. All photo transect data is checked by an experienced observer prior to analysis and reporting of results.

## **12.2 Instrument data management**

Data from instruments is currently limited to a set of Environmental Loggers, CTD Profilers and Temperature Loggers.

### **12.7.1 Fluorescence and turbidity loggers**

Wet Labs Eco FLNTUSB instruments are used to measure temperature, fluorescence, and turbidity (see Section 11 for details). After retrieval, the raw data are extracted in CSV format

using Wet Labs software and a serial communication port on a laptop. The calibration files and raw data files are backed up on a UNIX server which has a comprehensive backup regime. The data from the loggers are managed by the 'Environmental Logger Data Management' J2EE based web application that is accessed via any browser within the AIMS internal network by a select group of MMP staff. Data entry error is kept to minimum using pre-defined selection lists, and a set of import tasks. The Web Application is integrated with a dedicated Oracle database (the AIMS EnvLogger Database). Data import is discussed in Appendix A11.

### 12.7.2 CTD Profilers

At the MMP sites where Niskin samples are collected, Sea-Bird CTD Profilers are deployed to measure vertical profiles of salinity, temperature, conductivity, turbidity, fluorescence, and other parameters. Also, some time-series CTD instruments (Sea-Bird SBE37) are deployed at logger sites to record changes in salinity and temperature over time. Both instruments record data in the same format and are processed in a very similar fashion, the main difference being vertical casts are over depth (distance in meters) and *in situ* deployments are over time. For vertical and *in situ* deployments, Sea-Bird Sea-Save and SBE-DataProcessing software modules are used to produce data files in the Sea-Bird HEX format. These HEX files contain the raw data readings and are stored on a server which has a backup and retention policy that ensures the data files are retrievable as required over the long term. Each Sea-Bird CTD instrument (SBE37, SBE19plus, etc), calibration information is kept in a CON file.

The processing of the data is done via the CTD Data Management J2EE web services application, and the Sea-Bird DataProcessing Software. The HEX files and CON files are used as input to these. During the process, four PSA files are created for each data file, and these represent the initial QAQC process.

1. Raw data conversion PSA: Conversion of raw HEX characters to ASCII characters
2. Wild Edit PSA: 2 pass running mean filter/de-spike.
3. Loop Edit PSA: vertical shift correction (boat rocking due to swell)
4. Bin Average PSA: Data is averaged into 1 meter vertical bins for each parameter.

The creation of the four PSA files is automated by the CTD Data Management System using the HEX and CON files as input. Once the data has been Bin Averaged, the data is then ingested into an Oracle 9i database schema, within the same schema used to house the biogeochemical data.

### 12.7.3 Temperature loggers

Temperature loggers are deployed at, or in close proximity to, all locations at both 2m and 5m depths and routinely exchanged at the time of coral surveys.

There are two types of Temperature loggers used for the sea surface temperature logger program. The first type is an Odyssey temperature logger that comes with either 64 kb or 128 kb of memory (<http://www.odysseydatarecording.com/>). These are currently being phased out. The second type is a Sensus Ultra Temperature logger (<http://reefnet.ca/products/sensus/>). The Odyssey Temperature loggers are set to take readings every 30 minutes. The Sensus Temperature loggers are set to take readings every 10 minutes.

Prior to deployment, the Temperature loggers are calibrated to within 0.02 Degrees Celsius using a temperature bath and a Hart Scientific 1522 thermometer.

The deployment process involves deploying two Temperature loggers at a location designated by the experimental scientist. The first logger is deployed in shallow water on a reef flat. The second logger is deployed in deeper water on a reef slope. The temperature loggers are deployed for a period of approximately one year.

After the temperature loggers are retrieved the data is downloaded and imported into an Oracle database as raw or level 0 data. To accomplish this task the Odyssey loggers have proprietary software to download and transfer their data into a Microsoft Access database via a serial port. The software then uploads this data from the Access database into the Oracle database. The Sensus loggers download their data to a Microsoft Excel spreadsheet via a serial port. The spreadsheet is uploaded into the Oracle database using an Java application written by the AIMS data centre.

Quality control is performed on all temperature logger data using Wiski Time Series Viewer ([www.kisters.de/english/html/WISKI/WiskiTV.html](http://www.kisters.de/english/html/WISKI/WiskiTV.html)). The Wiski input files are generated using an Java application written by the AIMS data centre. Data from the same location (the flat and the slope) and nearby locations are plotted together for comparison. Any bad points are removed. If a logger has suffered any drift in its recorded data points this can be corrected using Wiski Time Series Viewer. After this process the data is inserted into the database as quality controlled or level1 data.

## 12.8 Data validation

As the previous section describes, the resulting data from sampling and instrumentation is ingested into several Oracle databases. Once the data are in Oracle, views are created of the data to simplify processing and hide the complexities of the underlying database schemas. The views are made available 3 mechanisms:

1. On-line forms via the Intranet.
2. On-line file downloads/exports.
3. Microsoft Access Databases.

All 3 give the scientist the data validation capability, and when issues with the data are found, they are addressed by fixing/removing the inconsistency in its raw format, then re-importing the values back into Oracle. Once back in Oracle, the provided views will reflect the changes made via data validation. Mechanisms for data validation are as follows;

- Bounds checking – is the data within acceptable limits.
- Logical checking – is the data logical (is the value possible).
- Comparative checking – is the data similar to other comparable data (such as previously collected data or better previous equivalent data).
- Correlative checking – if there is a relationship between two variables, if so is the relationship valid, if sample data should exist for this data, is it present.

## 12.9 Data integration

Once data is available in the Oracle databases after the quality assurance and validation processes have gone through the cycles, the data is then consolidated in an Access Database via Oracle views. The Access Database product was chosen as the delivery mechanism for its simplicity, and with a view that most are familiar with the software. Providing the Oracle database lends itself to database schema complexity and licensing issues for the software required to use the exported Oracle databases.

It is AIMS policy that all data collected have a metadata record created for it. The metadata record is created using a Metadata Entry System where the metadata is in the form of ISO19139 XML. This is the chosen format for many agencies across Australia and the International Community that deal with spatial scientific data. The AIMS Data Explorer is searchable by keyword and location and is found here:

<https://apps.aims.gov.au/metadata/search>.

## 12.10 Outputs

The outputs from the data management system include Standard Operating Procedures for all data manipulation, transfer, uploading and processing, a full database description, the metadata records, the data quality reports from the automated checking programs, the progress statistics from the data tracking system and a copy of the data in the appropriate format (such as an Access Database).

## Appendix B Waypoints for Coral Monitoring Transects

**Appendix B1 Waypoints for the start of Transect 1 of each coral site reported by the MMP. Reefs in Italics are monitored by the AIMS Long-term Monitoring Program**

NRM Region	Catchment	Monitoring location	Site #	Depth (m)	Longitude	Latitude		
Wet Tropics		<i>Low Isles</i>	1	6	145.571000	-16.384000		
			2	6	145.572600	-16.386483		
			3	6	145.573450	-16.390217		
		Snapper North	1	2	145.496883	-16.292400		
			1	5	145.496517	-16.291883		
			2	2	145.500583	-16.295833		
			2	5	145.500367	-16.294867		
			3	2	145.506967	-16.301833		
		<i>Snapper South</i>	1	2	145.496000	-16.299750		
			1	5	145.495950	-16.299867		
			2	2	145.499367	-16.300767		
			2	5	145.499367	-16.301067		
			3	2	145.501967	-16.302117		
		Fitzroy East	1	2	146.006217	-16.923833		
			1	5	146.006867	-16.924100		
			2	2	145.991170	-16.943290		
		Fitzroy West	2	5	145.991133	-16.943533		
			1	2	145.996267	-16.923317		
			1	5	145.996250	-16.923150		
			2	2	145.999633	-16.922100		
		<i>Fitzroy West</i>	2	5	145.999633	-16.922100		
			1	6	145.993000	-16.923000		
			2	6	145.996083	-16.923067		
		Frankland East	3	6	145.999317	-16.921950		
			1	2	146.076750	-17.203783		
			1	5	146.077000	-17.203250		
			2	2	146.090250	-17.219550		
					2	5	146.091433	-17.219100

NRM Region	Catchment	Monitoring location	Site #	Depth (m)	Longitude	Latitude		
		Frankland West	1	2	146.090367	-17.226967		
			1	5	146.090367	-17.226967		
			2	2	146.075967	-17.212467		
			2	5	146.075733	-17.212583		
		High East	1	2	146.014700	-17.158150		
			1	5	146.014817	-17.158433		
			2	2	146.012450	-17.163217		
			2	5	146.012833	-17.163683		
		High West	1	2	146.006983	-17.162150		
			1	5	146.006983	-17.162150		
			2	2	146.005750	-17.160050		
			2	5	146.005750	-17.160050		
	Herbert Tully	Barnards	1	2	146.174200	-17.672233		
			1	5	146.174583	-17.671750		
			2	2	146.179500	-17.673900		
			2	5	146.179500	-17.673900		
		Bedarra	1	2	146.148040	-18.009370		
			1	5	146.148080	-18.009700		
			2	2	146.146440	-18.008690		
			2	5	146.146380	-18.009020		
		Dunk North	1	2	146.136800	-17.923700		
			1	5	146.137300	-17.923317		
			2	2	146.146133	-17.926283		
			2	5	146.146133	-17.926283		
		Dunk South	1	2	146.154333	-17.958850		
			1	5	146.154350	-17.959083		
			2	2	146.143867	-17.957000		
			2	5	146.143850	-17.957317		
		Bur deki	Bur deki	Havannah Island	1	2	146.542833	-18.847217
					1	5	146.542700	-18.847550
					2	2	146.540683	-18.846367
					2	5	146.540583	-18.846683
1	6				146.537000	-18.832000		
		<i>Havannah Island (North)</i>						

NRM Region	Catchment	Monitoring location	Site #	Depth (m)	Longitude	Latitude		
			2	6	146.541367	-18.834000		
			3	6	146.545083	-18.835683		
		Lady Elliot	1	2	146.332467	-18.679850		
			1	5	146.333033	-18.680167		
			2	2	146.331767	-18.681833		
			2	5	146.332067	-18.682350		
			2	5	146.332067	-18.682350		
		Magnetic	1	2	146.868517	-19.154833		
			1	5	146.868483	-19.154950		
			2	2	146.862150	-19.156217		
			2	5	146.862200	-19.156783		
		Palms East	1	2	146.494683	-18.571783		
			1	5	146.495067	-18.571733		
			2	2	146.496240	-18.574330		
			2	5	146.497150	-18.574450		
		Palms West	1	2	146.482317	-18.569117		
			1	5	146.482017	-18.569067		
			2	2	146.488767	-18.540583		
			2	5	146.488550	-18.540583		
		Pandora	1	2	146.435983	-18.814033		
			1	5	146.436317	-18.814050		
			2	2	146.434067	-18.816400		
			2	5	146.434567	-18.816800		
		<i>Pandora (North)</i>	1	6	146.427000	-18.813000		
			2	6	146.430050	-18.811567		
			3	6	146.432650	-18.810700		
		Mackay Whitsunday	Proserpine	<i>Border</i>	1	6	149.036000	-20.175000
					2	6	149.037717	-20.181900
					3	6	149.031967	-20.170967
				Daydream	1	2	148.812417	-20.255617
					1	5	148.812150	-20.255750
					2	2	148.812450	-20.253433
					2	5	148.812283	-20.253450
				Dent	1	2	148.938217	-20.344983

NRM Region	Catchment	Monitoring location	Site #	Depth (m)	Longitude	Latitude		
			1	5	148.938217	-20.344983		
			2	2	148.937050	-20.347433		
			2	5	148.937050	-20.347433		
		Double Cone	1	2	148.721750	-20.104817		
			1	5	148.721750	-20.104917		
			2	2	148.718850	-20.105733		
			2	5	148.719017	-20.105950		
		Hayman	1	6	148.899000	-20.057000		
			2	6	148.901650	-20.059667		
			3	6	148.903933	-20.062033		
		Hook	1	2	148.887133	-20.168117		
			1	5	148.887133	-20.168117		
			2	2	148.883933	-20.165717		
			2	5	148.883933	-20.165717		
		Pine	1	2	148.888367	-20.377983		
			1	5	148.888367	-20.377983		
			2	2	148.886400	-20.375450		
			2	5	148.886400	-20.375450		
		Seaforth	1	2	149.038950	-20.468450		
			1	5	149.038950	-20.468450		
			2	2	149.037150	-20.471900		
			2	5	149.037150	-20.471900		
		Shute	1	2	148.803217	-20.301733		
			1	5	148.803217	-20.301733		
			2	2	148.798283	-20.300850		
			2	5	148.798283	-20.300850		
		Fitzroy	Fitzroy	Barren	1	2	151.070467	-23.157483
					1	5	151.070467	-23.157483
					2	2	151.072900	-23.156583
					2	5	151.072900	-23.156583
				Keppels South	1	2	150.963783	-23.216150
					1	5	150.963400	-23.216267
2	2				150.969783	-23.202467		

NRM Region	Catchment	Monitoring location	Site #	Depth (m)	Longitude	Latitude
			2	5	150.969783	-23.202683
		Middle	1	2	150.920550	-23.161533
			1	5	150.920633	-23.161467
			2	2	150.923967	-23.163900
		North Keppel	1	2	150.905183	-23.086450
			1	5	150.905183	-23.086450
			2	2	150.901733	-23.085217
			2	5	150.901733	-23.085217
		Peak	1	2	150.936867	-23.341267
			1	5	150.937000	-23.340950
			2	2	150.938833	-23.341683
			2	5	150.938933	-23.341400
		Pelican	1	2	150.874183	-23.239667
			1	5	150.874483	-23.238917
			2	2	150.878083	-23.242050
			2	5	150.878500	-23.241783